

Directional spool valves, direct operated, with solenoid actuation

Type WE ...XE

RE 23178-XE

Edition: 2017-05

Replaces: 2016-04

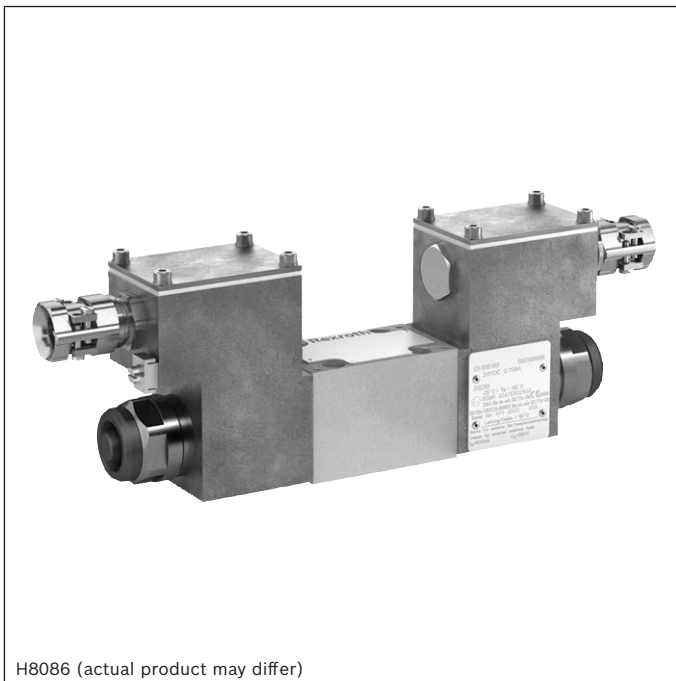

H8086 (actual product may differ)

- ▶ Size 6
- ▶ Component series 5X
- ▶ Maximum operating pressure 350 bar
- ▶ Maximum flow 70 l/min



ATEX units

For potentially explosive atmospheres



Information on the explosion protection:

- ▶ Area of application in accordance with the Explosion Protection Directive 2014/34/EU: **II 2G**
- ▶ Type of protection of the valve solenoids:
Ex eb mb IIC T4 Gb according to
EN 60079-7 / EN 60079-18

Features

- ▶ 4/3-, 4/2- or 3/2-way version
- ▶ For intended use in potentially explosive atmosphere
- ▶ Porting pattern according to ISO 4401-03-02-0-05
- ▶ Wet-pin DC or AC solenoids
- ▶ Electrical connection with individual connection and cable gland
- ▶ With manual override, optional

Contents

Features	1
Ordering code	2
Symbols	3, 4
Function, section	5
Technical data	6, 7
Characteristic curves	8, 9
Performance limits	10, 11
Dimensions	12
Installation conditions	13
Electrical connection	14
Over-current fuse and switch-off voltage peaks	15
Further information	15

Ordering code

01	02	03	04	05	06	07	08	09	10	11	12	13	
	WE	6		6X	/		E			XE	Z2	/	

01	3 main ports	3
	4 main ports	4
02	Directional valve	WE
03	Size 6	6
04	Symbols e. g. C, E, EA, EB, etc; possible version, see page 3	
05	Component series 60 ... 69 (60 ... 69: unchanged installation and connection dimensions)	6X
06	With spring return	no code
	Without spring return	O
	Without spring return with detent	OF
07	High-power solenoid, wet (wet-pin)	E

Voltage

08	Direct voltage 24 V	G24
	AC voltage 230 V, 50/60 Hz	W230
	For further ordering codes for other voltages and frequencies, see page 7	
09	Without manual override	no code
	With manual override	N

Explosion protection

10	"Increased safety"	XE
	For details, see information on the explosion protection, page 7	

Electrical connection

11	Individual connection	
	Solenoid with terminal box and cable gland	Z2
	For details of electrical connections, see page 14	
12	Without throttle insert	no code
	Throttle Ø 0.8 mm	B08
	Throttle Ø 1.0 mm	B10
	Throttle Ø 1.2 mm	B12
	Use with flows which exceed the performance limit of the valve (see page 5)	

Seal material

13	NBR seals	no code
	FKM seals	V
	Observe compatibility of seals with hydraulic fluid used. (Other seals upon request)	



Notice:

The manual override cannot be allocated a safety function and may only be used up to a tank pressure of 50 bar.

Symbols: 2 spool positions

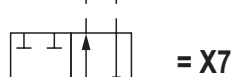
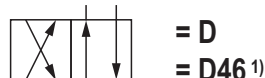
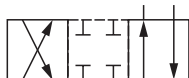
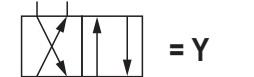
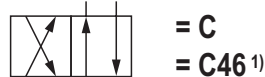
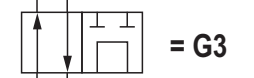
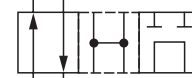
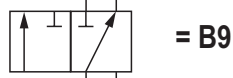
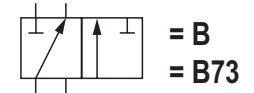
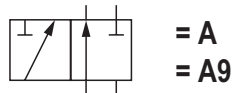
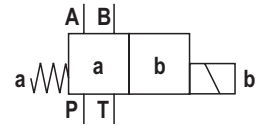
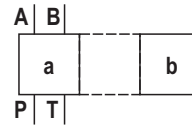
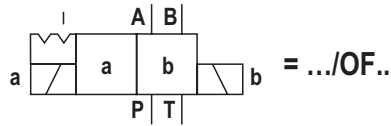
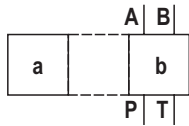
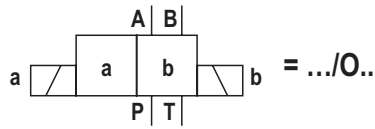
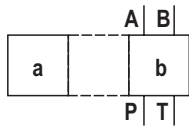
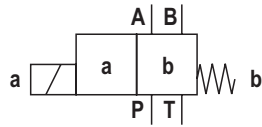
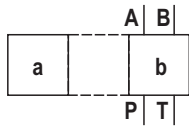

¹⁾ For valves with AC solenoids and detent, only C46/OF and D46/OF are admissible.

Notice:

Representation according to DIN ISO 1219-1.
Hydraulic interim positions are shown by dashes.

Symbols: 3 spool positions

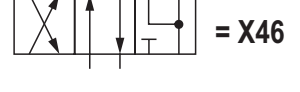
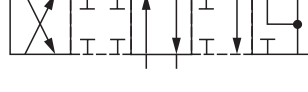
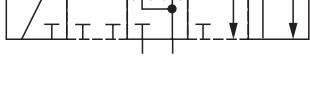
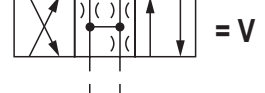
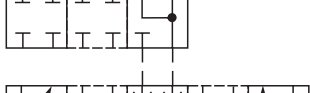
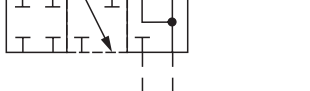
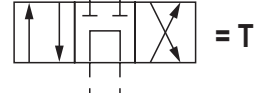
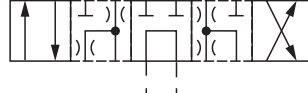
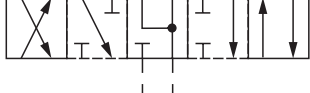
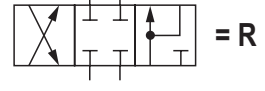
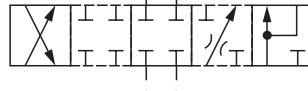
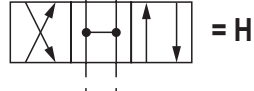
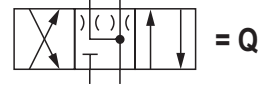
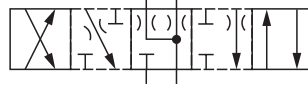
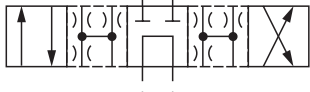
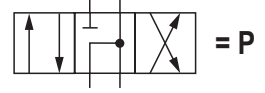
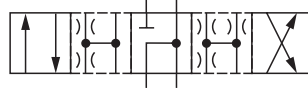
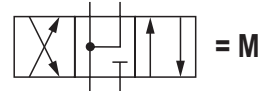
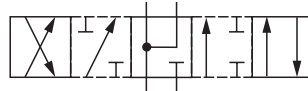
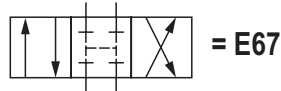
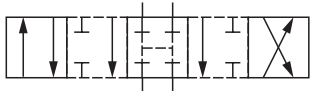
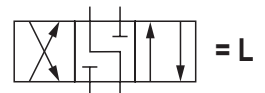
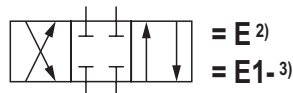
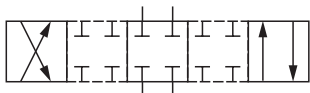
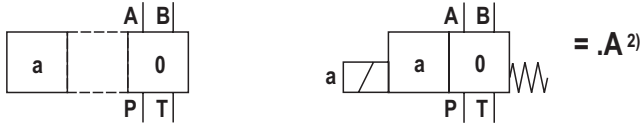
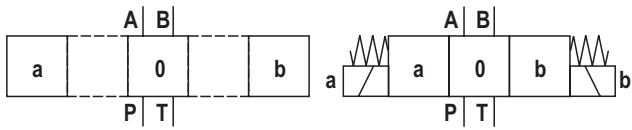

2) **Example:**

Symbol E with switching position "a" ordering code ..EA..

3) Symbol E1-: P – A/B pre-opening,

Caution in conjunction with differential cylinders due to pressure intensification

Notices:

Representation according to DIN ISO 1219-1.

Hydraulic interim positions are shown by dashes.

Function, section

Directional valves of type WE are solenoid-actuated directional spool valves. They control start, stop and direction of a flow.

The directional valves basically consist of housing (1), one or two solenoids (2), control spool (3), and one or two return springs (4).

In the de-energized condition, control spool (3) is held in the central position or in the initial position by the return springs (4) (except for impulse spool). The control spool (3) is actuated by wet-pin solenoids (2).

To ensure proper functioning, care must be taken that the pressure chamber of the solenoid is filled with oil.

The force of solenoid (2) acts via plunger (5) on control spool (3) and pushes the latter from its rest position to the required end position. This enables the necessary direction of flow from P → A and B → T or P → B and A → T.

After solenoid (2) was de-excitated, the return spring (4) pushes control spool (3) back to its rest position.

A manual override (6) allows control spool (3) to be moved without solenoid energization.

Without spring return "O" (only possible with symbols A, C and D)

This version is a directional valve with two spool positions and two solenoids without detent. In the de-energized condition, there is no defined spool position.

With spring return "OF" (impulse spool, only possible with symbols A, C and D)

This version is a directional valve with two spool positions, two solenoids and one detent. It alternately locks the two spool positions and the solenoid therefore does not need to be permanently energized.

 **Notice:**

Pressure peaks in the tank line to two or several valves can result in unintended movements of the control spool in case of valves with detent. We therefore recommend that separate return lines be provided or a check valve installed in the tank line.

For design reasons, internal leakage is inherent to the valves, which may increase over the life cycle.

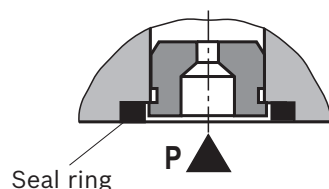
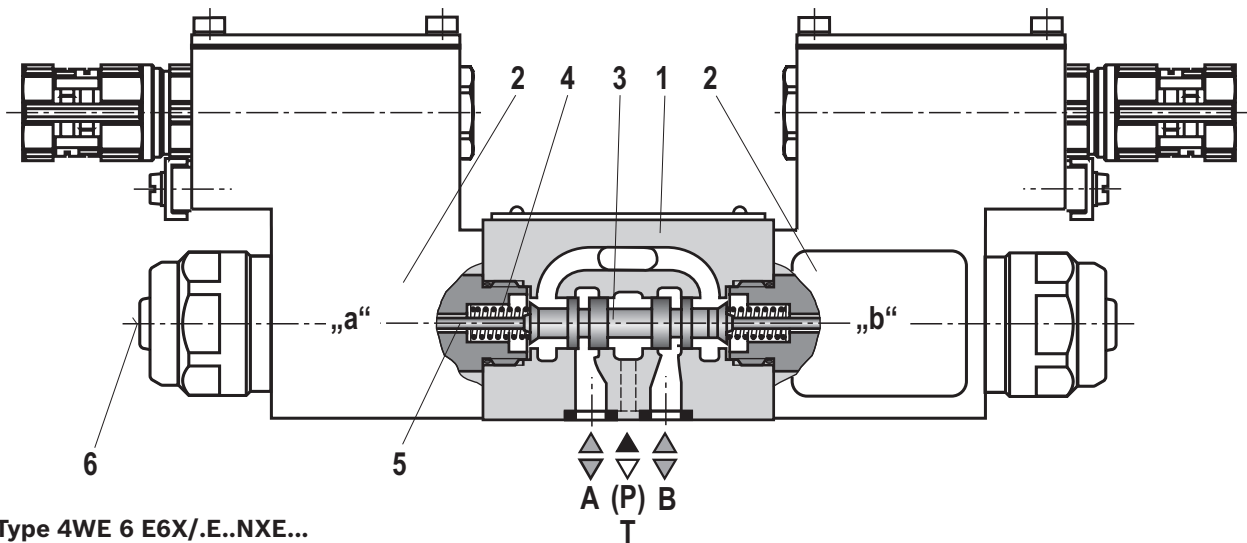

Throttle insert "...B"

The use of a throttle insert is required when, due to prevailing operating conditions, flows occur during the switching processes, which exceed the performance limit of the valve.

Technical data

(For applications outside these parameters, please consult us!)

general	
Installation position	any
Ambient temperature range	°C –20 ... +70 ¹⁾
Storage temperature range	°C +5 ... +40
Maximum storage time	Years 1
Weight	kg 2.6 (with 1 solenoid); 4.0 (with 2 solenoids)
Surface protection	Galvanized

hydraulic			
Maximum operating pressure	▶ Port A, B, P	bar	350
	▶ Port T	bar	210 With symbols A and B, port T must be used as leakage oil connection if the operating pressure exceeds the admissible tank pressure.
Maximum flow		l/min	70
Flow cross-section (spool position 0)	▶ Symbol Q	mm ²	Approx. 6 % of nominal cross-section
	▶ Symbol W	mm ²	Approx. 3 % of nominal cross-section
Hydraulic fluid	See table below		
Hydraulic fluid temperature range		°C	–20 ... +80 (NBR seals) –15 ... +80 (FKM seals)
Viscosity range		mm ² /s	2.8 ... 500
Maximum admissible degree of contamination of the hydraulic fluid Cleanliness class according to ISO 4406 (c)	Class 20/18/15 ²⁾		
Maximum surface temperature		°C	See information on the explosion protection, page 7

Hydraulic fluid	Classification	Suitable sealing materials	Standards	Data sheet
Mineral oils	HL, HLP, HLPD	NBR, FKM	DIN 51524	90220
Bio-degradable	▶ Insoluble in water	HETG	ISO 15380	90221
		HEES		
	▶ Soluble in water	HEPG	ISO 15380	
Flame-resistant	▶ Containing water	HFC (Fuchs Hydrotherm 46M, Petrofer Ultra Safe 620)	NBR	ISO 12922 90223

Important information on hydraulic fluids:

- ▶ For further information and data on the use of other hydraulic fluids, please refer to the data sheets above or contact us!
- ▶ There may be limitations regarding the technical valve data (temperature, pressure range, life cycle, maintenance intervals, etc.)!
- ▶ Ignition temperature > 180 °C

▶ Flame-resistant – containing water:

- Maximum pressure differential per control edge 50 bar
- Pressure pre-loading at the tank port > 20 % of the pressure differential, otherwise increased cavitation
- Life cycle as compared to operation with mineral oil HL, HLP 50 ... 100 %

¹⁾ Observe the "Special application conditions for safe application" on page 7.

²⁾ The cleanliness classes specified for the components must be adhered to in hydraulic systems. Effective filtration prevents faults and at the same time increases the life cycle of the components.
For the selection of the filters, see www.boschrexroth.com/filter.

Technical data

(For applications outside these parameters, please consult us!)

electric				
Voltage type		Direct voltage	Alternating voltage	
Available voltages	V	24, 48, 96, 110	110, 230	
Voltage tolerance (nominal voltage)	%	±10		
Admissible residual ripple	%	< 5	–	
Duty cycle / operating mode according to VDE 0580		S1 (continuous operation)		
Switching times according to ISO 6403 ³⁾	▶ ON	ms	30 ... 55	40 ... 80
	▶ OFF	ms	10 ... 15	40 ... 50
Maximum switching frequency	1/h	15000	7200	
Nominal power at ambient temperature 20 °C	W	17		
Maximum power with 1.1 x nominal voltage and ambient temperature 20 °C	W	20.6		
Protection class according to EN 60529		IP 66 (with correctly installed electrical connection)		

Information on the explosion protection	
Area of application according to directive 2014/34/EU	II 2G
Type of protection valve	c (EN 13463-5)
Maximum surface temperature ⁴⁾	°C 135
Temperature class	T4
Type of protection valve solenoid according to EN 60079-7 / EN 60079-18	Ex eb mb IIC T4 Gb
Type examination certificate Solenoid	KEMA 02ATEX2240 X
"IECEX Certificate of Conformity" solenoid	IECEX DEK 12.0068X
Special application conditions for safe application	<ul style="list-style-type: none"> ▶ In case of valves with two solenoids, maximally one of the solenoids may be energized at a time. ▶ Simultaneous power supply of several valves in bank assembly is possible if the ambient temperature does not exceed 60 °C. ▶ In case of bank assembly, if only one of the solenoids is energized at a time, and during individual operation, the maximum ambient temperature may not exceed 70 °C. ▶ The maximum temperature of the surface of the valve jacket is 120 °C. This has to be considered when selecting the connection cable and/or contact of the connection cable with the surface of the jacket is to be prevented.
Ambient temperature range	°C –20 ... +70 ⁵⁾

³⁾ The switching times were determined at a hydraulic fluid temperature of 40 °C and a viscosity of 46 cSt. Deviating hydraulic fluid temperatures can result in different switching times! Switching times change dependent on operating time and application conditions.

⁴⁾ Surface temperature > 50 °C, provide contact protection

⁵⁾ Observe the "Special application conditions for safe application" in the above table

Characteristic curves

(measured with HLP46, $\vartheta_{oil} = 40 \pm 5 \text{ }^\circ\text{C}$)

Δp - q_V characteristic curves

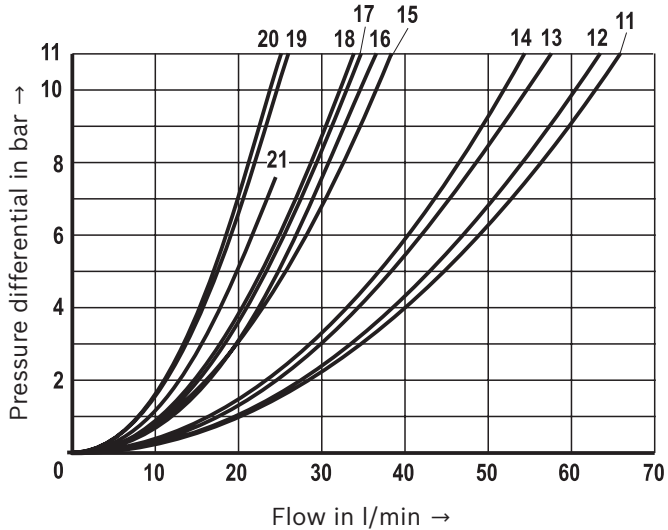
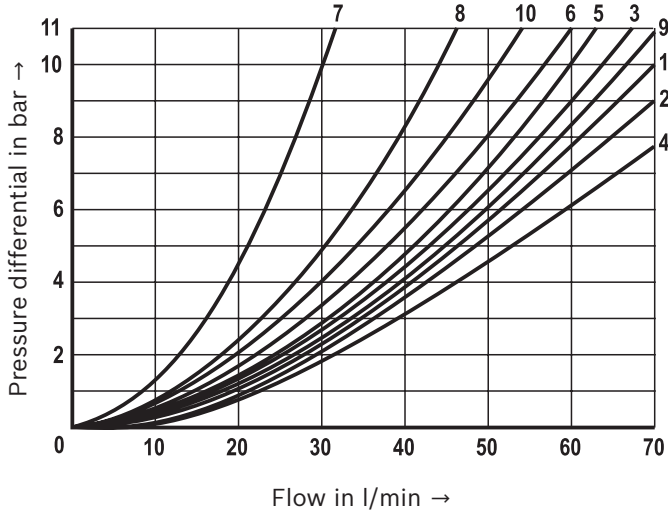

Symbol	Direction of flow					
	P - A	P - B	A - T	B - T	B - A	P - T
A, B	3	3	-	-	-	-
C46, C	1	1	3	1	-	-
D46, D, Y	5	5	3	3	-	-
E	3	3	1	1	-	-
F	1	3	1	1	-	-
T	10	10	9	9	-	8
H	2	4	2	2	-	9
J, Q	1	1	2	1	-	-
L	3	3	4	9	-	-
M	2	4	3	3	-	-
P	3	1	1	1	-	-
R	5	5	4	-	7	-
V	1	2	1	1	-	-
W	1	1	2	2	-	-
U	3	3	9	4	-	-
G, G3	6	6	9	9	-	8
G73	20	20	19	19	-	16
E67	14	13	11	12	-	-
B9	17	15	-	-	-	-
B73	18	21	-	-	-	-

Characteristic curves
(measured with HLP46, $\vartheta_{oil} = 40 \pm 5 \text{ }^\circ\text{C}$)

Δp - q_v characteristic curves

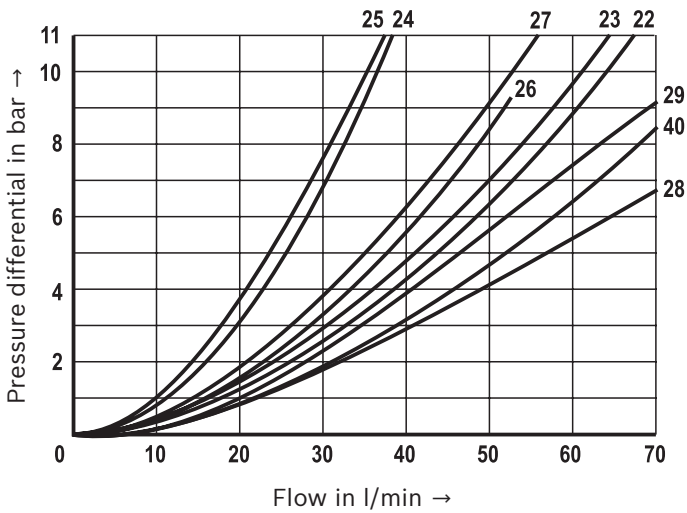

Symbol	Direction of flow					
	P - A	P - B	A - T	B - T	B - A	P - T
J73	24	25	23	22	-	-
J19	27	-	39	39	-	-
X7	29	-	-	28	-	-
X46	32	33	31	30	-	-
J32	22	-	-	40	-	-
D19	36	-	38	37	-	-
Q48	42	41	-	-	-	43

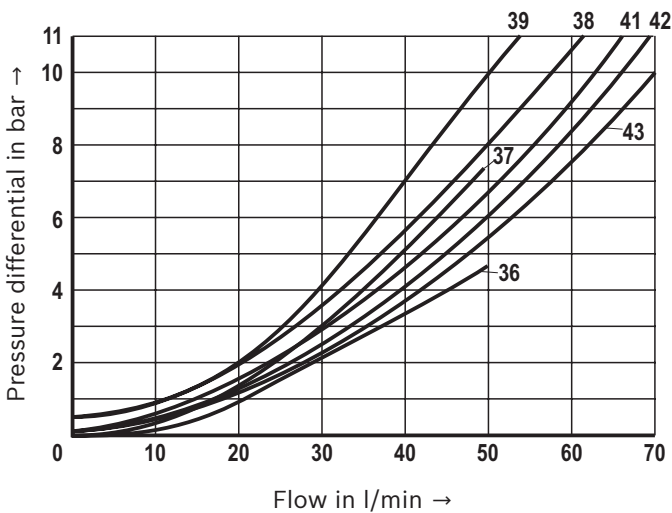
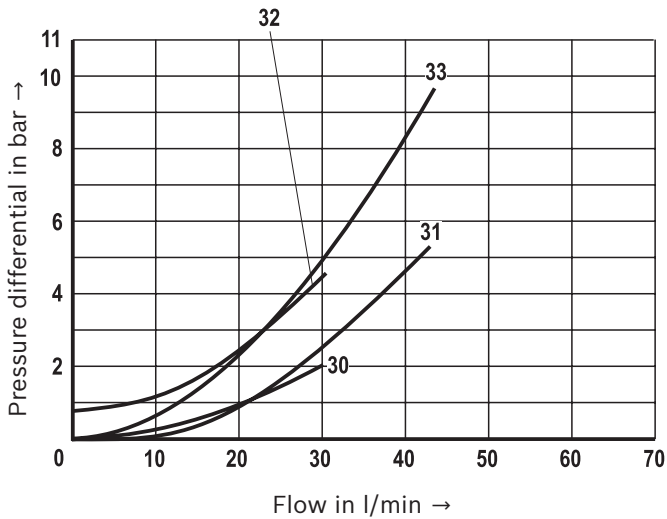

Performance limits: Version "G24"
(measured with HLP46, $\vartheta_{oil} = 40 \pm 5 \text{ }^\circ\text{C}$)

Notice:

The specified performance limits are valid for use with two directions of flow (e. g. from P → A and simultaneous return flow from B to T).
Due to the flow forces acting within the valves, the admissible performance limit may be considerably

lower with only one direction of flow (e. g. from P → A while port B is blocked)!
In such cases, please consult us!

The performance limits were determined when the solenoids were at operating temperature, at 10 % undervoltage and without tank preloading.

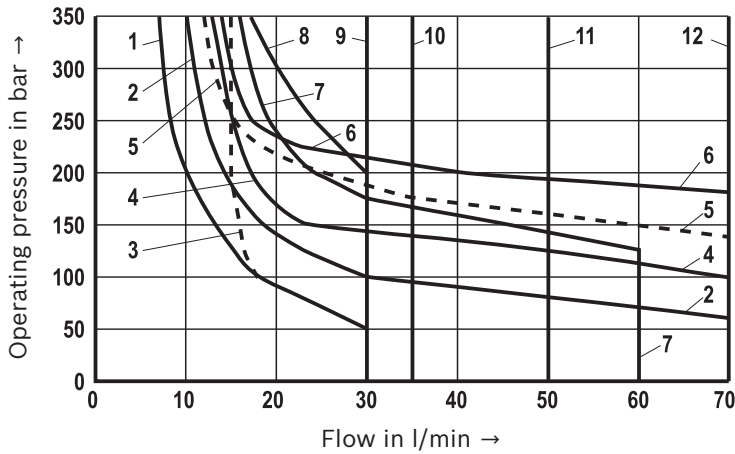

Characteristic curve	Symbol
1	A, B
2	J, L, U
3	V
4	D, C, Y
5	Q, W
6	E
7	A/O, A/OF
8	F, P
9	T
10	G
11	H, D/O
12	E1 ¹⁾ , R ²⁾ , M

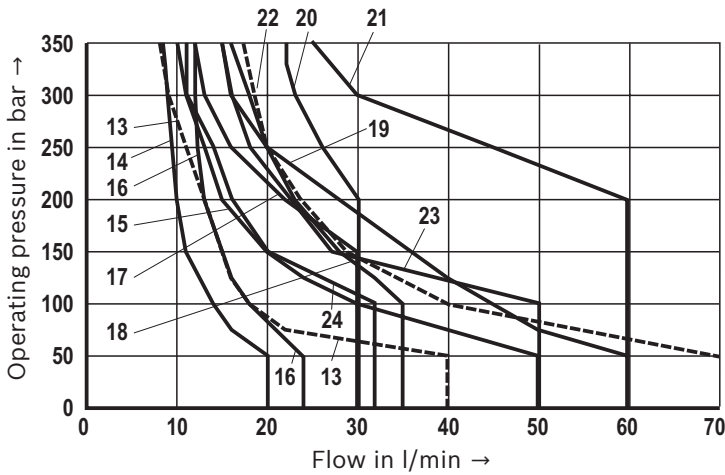

Characteristic curve	Symbol
13	A9 / B9
14	E67
15	J19, B-T
16	B73
17	X46
18	J73
19	J19 (A-T)
20	G73
21	X7
22	J19 (P-A)
23	G3
24	Q48

1) P – A/B pre-opening
2) Return flow from actuator to tank

Performance limits: Version "G48", "G96", "G110", "W110" and "W230"
 (measured with HLP46, $\vartheta_{oil} = 40 \pm 5 \text{ } ^\circ\text{C}$)

Notice:

The specified performance limits are valid for use with two directions of flow (e. g. from P → A and simultaneous return flow from B to T).
 Due to the flow forces acting within the valves, the admissible performance limit may be considerably

lower with only one direction of flow (e. g. from P → A while port B is blocked)!

In such cases, please consult us!

The performance limits were determined when the solenoids were at operating temperature, at 10 % undervoltage and without tank preloading.

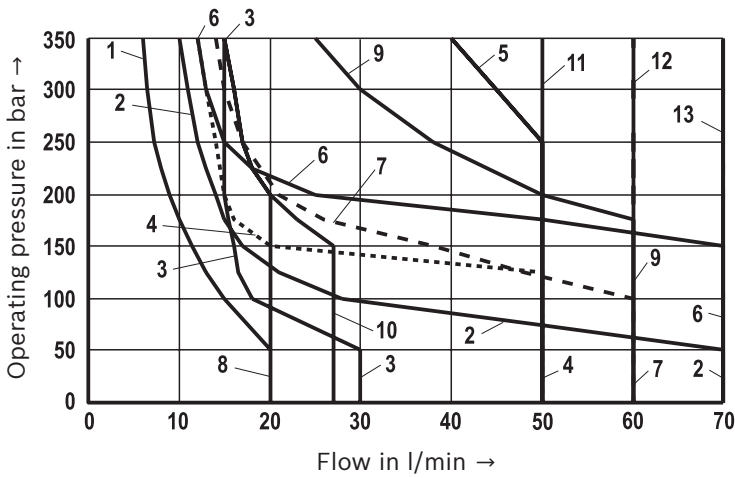

Characteristic curve	Symbol
1	A, B
2	J, L, U, Q, W
3	V
4	D, C, Y
5	C46/OF, D46/OF
6	E
7	A/O
8	F, P, T
9	R ²⁾
10	G
11	H
12	M, D/O, C/O
13	E1 ¹⁾

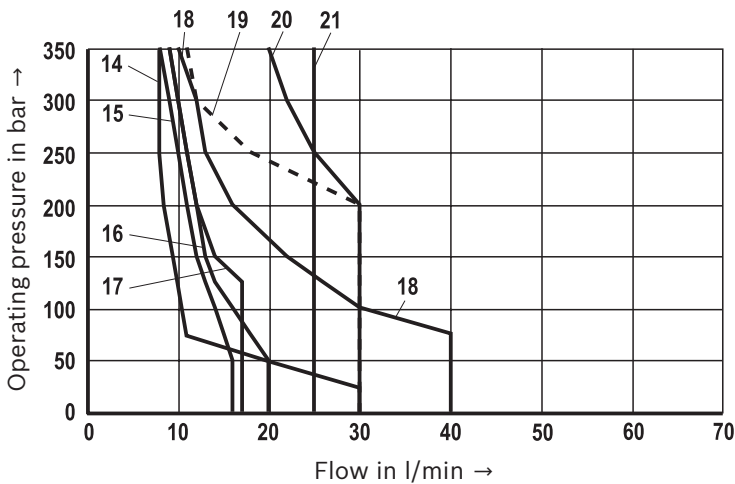

Characteristic curve	Symbol
14	B9
15	J32 (B-T)
16	J19, B-T
17	D19
18	J19 (A-T)
19	X7
20	G73
21	J32 (A-T)

¹⁾ P – A/B pre-opening

²⁾ Return flow from actuator to tank

Dimensions

(dimensions in mm)

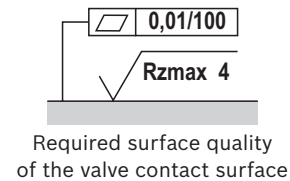
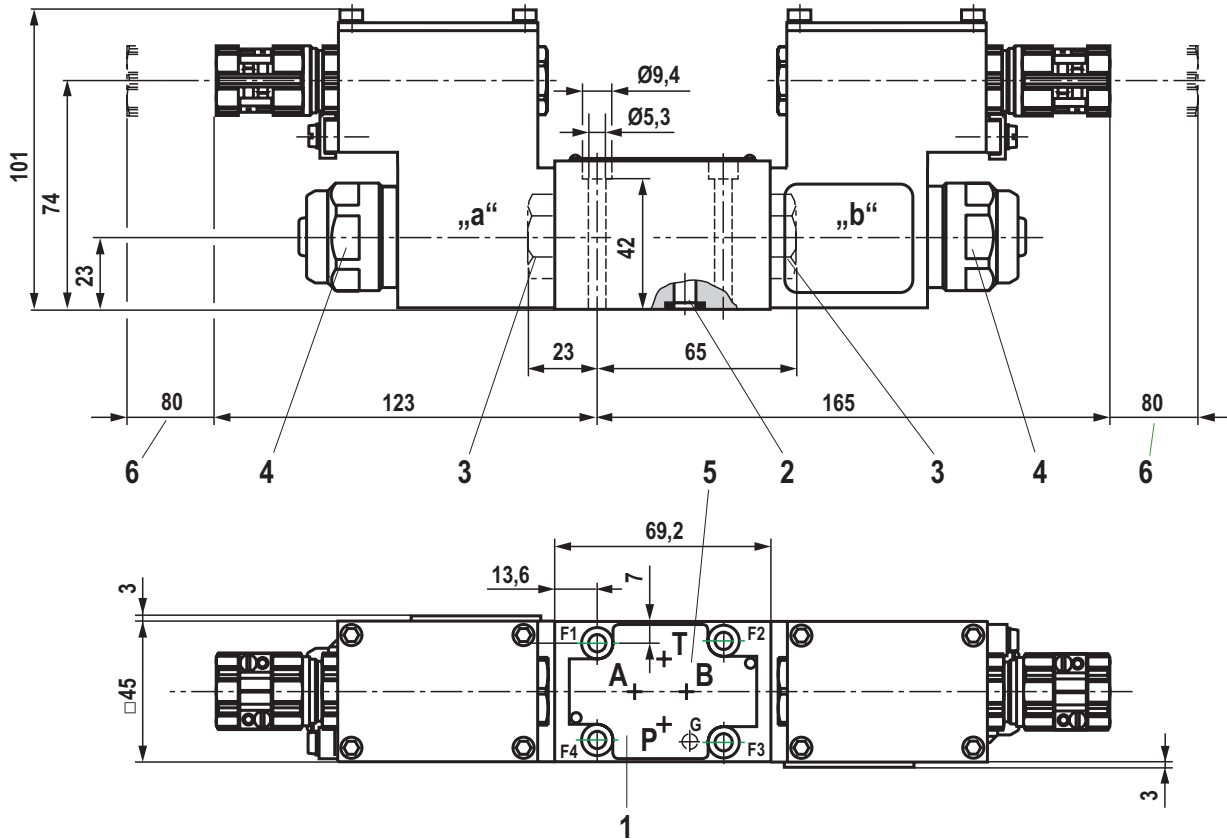

- 1 Name plate
- 2 Identical seal rings for ports A, B, P, T
- 3 Plug screw for valves with one solenoid
- 4 Mounting nut with hexagon, wrench size 32
tightening torque $M_A = 4^{+1}$ Nm
- 5 Porting pattern according to ISO 4401-03-02-0-05
(with locating hole for locking pin ISO 8752-3x8-St,
material no. **R900005694**, separate order)
- 6 Space required to remove the solenoid coil

Valve mounting screws (separate order)

For reasons of stability, exclusively use the following valve mounting screws:

4 hexagon socket head cap screws
ISO 4762 - M5 x 50 - 10.9-fIZn-240h-L
 (friction coefficient $\mu_{\text{total}} = 0.09$ to 0.14);
 tightening torque $M_A = 7$ Nm ± 10 %, material no. **R913000064**

Subplates (separate order) with porting pattern according to ISO 4401-03-02-0-05, see data sheet 45100.

Notice:

Subplates are no components in the sense of directive 2014/34/EU and can be used after the manufacturer of the overall system has conducted an assessment of the risk of ignition. The "G...J3" versions are free from aluminum and/or magnesium and galvanized.

Installation conditions (dimensions in mm)

	Individual assembly	Bank assembly
Subplate dimensions	Minimum dimensions Length ≥ 64 , width ≥ 58 , height ≥ 25	Minimum cross-section Height ≥ 60 , width ≥ 85
Thermal conductivity of the subplate	≥ 38 W/mK (EN-GJS-500-7)	
Minimum distance between the longitudinal valve axes	≥ 55 mm	

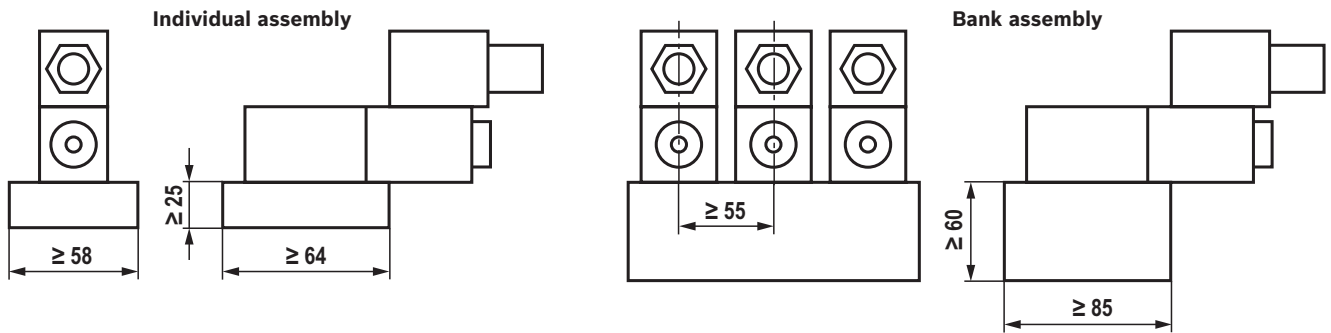

 **Notice:**

Observe the "Special application conditions for safe application" on page 7.

Electrical connection

The type-examination tested valve solenoid of the valve is equipped with one terminal box and a type-tested cable entry.

The connection is polarity-independent.

Solenoids to be connected to AC voltage are equipped with an integrated rectifier.



Notice:

When establishing the electrical connection, the protective earthing conductor (PE \perp) has to be connected properly.

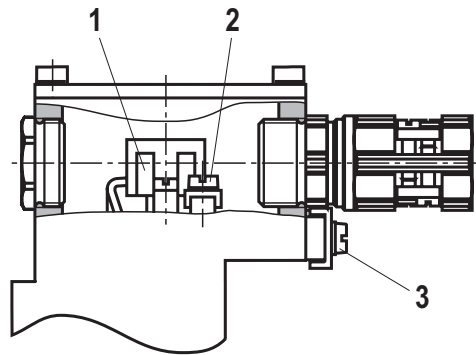

Properties of the connection terminals and mounting elements

Position	Function	Connectable line cross-section
1	Operating voltage connection	Single-wire 0.75 ... 2.5 mm ² Finely stranded 0.75 ... 1.5 mm ²
2	Connection for protective earthing conductor	Single-wire max. 2.5 mm ² Finely stranded max. 1.5 mm ²
3	Connection for potential equalization conductor	Single-wire 4 ... 6 mm ² Finely stranded min. 4 mm ²

Cable gland

Type approval	II 2G Ex e IIC Gb
Threaded connection	M20 x 1.5
Protection class according to EN 60529	IP66 (with correctly installed electrical connection)
Line diameter	mm 7 ... 10.5
Sealing	Outer sheath sealing

Connection line

Line type	Non-armored cables and lines (outer sheath sealing)
Temperature range	°C -30 ... > +110

Direct voltage, polarity-independent

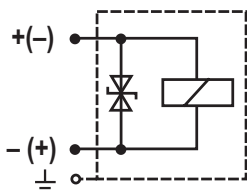

Alternating voltage

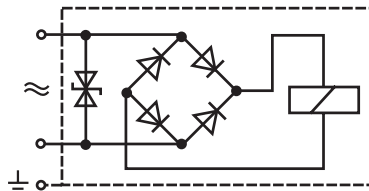

Over-current fuse and switch-off voltage peaks

Voltage data in the valve type code	Nominal voltage valve solenoid	Rated current valve solenoid	Rated current external miniature fuse: medium time-lag (M) according to DIN 41571 and EN/IEC 60127	Rated voltage external miniature fuse: medium time-lag (M) according to DIN 41571 and EN/IEC 60127	Maximum voltage value upon switch-off	Interference protection circuit
G24	24 V DC	0.708 A DC	800 mA	250 V	-90 V	Suppressor diode bi-directional
G48	48 V DC	0.354 A DC	400 mA	250 V	-200 V	
G96	96 V DC	0.177 A DC	200 mA	250 V	-370 V	
G110	110 V DC	0.155 A DC	200 mA	250 V	-390 V	
W110R	110 V AC	0.163 A AC	200 mA	250 V	-3 V	Bridge rectifier and suppressor diode
W230R	230 V AC	0.078 A AC	80 mA	250 V	-3 V	

Notice:

A fuse which corresponds to the rated current according to DIN 41571 and EN / IEC 60127 has to be connected upstream of every valve solenoid (max. $3 \times I_{\text{rated}}$).
The shut-off threshold of the fuse has to match the prospective short-circuit current of the supply source.
The prospective short-circuit current of the supply source may amount to a maximum of 1500 A.

This fuse may only be installed outside the potentially explosive atmosphere or must be of an explosion-proof design.
When inductivities are switched off, voltage peaks result which may cause faults in the connected control electronics.
The voltage peak must be damped by a suitable external circuitry.
We recommend a circuitry with a suppressor diode with a limitation voltage of approx. 50 V.

Further information

- ▶ Subplates
- ▶ Use of non-electrical hydraulic components in an explosive environment (ATEX)
- ▶ Hydraulic fluids on mineral oil basis
- ▶ Environmentally compatible hydraulic fluids
- ▶ Flame-resistant hydraulic fluids - containing water (HFAE, HFAS, HFB, HFC)
- ▶ Directional spool valves, direct operated, with solenoid actuation
- ▶ Selection of filters
- ▶ Information on available spare parts

Data sheet 45100

Data sheet 07011

Data sheet 90220

Data sheet 90221

Data sheet 90223

Operating instructions 23178-XE-B

www.boschrexroth.com/filter

www.boschrexroth.com/spc

Notes

Bosch Rexroth AG
Hydraulics
Zum Eisengießer 1
97816 Lohr am Main, Germany
Phone +49 (0) 93 52/ 18-0
documentation@boschrexroth.de
www.boschrexroth.de

© This document, as well as the data, specifications and other information set forth in it, are the exclusive property of Bosch Rexroth AG. It may not be reproduced or given to third parties without its consent.
The data specified above only serve to describe the product. No statements concerning a certain condition or suitability for a certain application can be derived from our information. The information given does not release the user from the obligation of own judgment and verification. It must be remembered that our products are subject to a natural process of wear and aging.