

Directional spool valves, direct operated,  
with solenoid actuation

Type WE

**RE 23340**

Edition: 2019-05

Replaces: 2015-07



- ▶ Size 10
- ▶ Component series 5X
- ▶ Maximum operating pressure 350 bar [5076 psi]
- ▶ Maximum flow: 160 l/min [42.3 US gpm] – DC  
120 l/min [31.7 US gpm] – AC

**Features**

- ▶ 4/3-, 4/2- or 3/2-way version
- ▶ Porting pattern according to ISO 4401-05-04-0-05 and NFPA T3.5.1 R2-2002 D05
- ▶ High-power solenoid, optionally rotatable by 90°
- ▶ Electrical connection as individual or central connection
- ▶ Cartridge optionally equipped with PWM connector (fast switching amplifier, energy reduction)
- ▶ Manual override, optional
- ▶ CE conformity according to the Low-Voltage Directive 2014/35/EU for electrical voltages > 50 VAC or > 75 VDC
- ▶ Solenoid coil as approved component with UR marking according to UL 906, edition 1982, optional
- ▶ Approval according to CSA C22.2 No. 139-13, optional

**Contents**

|                                    |           |
|------------------------------------|-----------|
| Features                           | 1         |
| Ordering code                      | 2 ... 7   |
| Symbols                            | 8, 9      |
| Function, section                  | 10        |
| Technical data                     | 11 ... 14 |
| Characteristic curves              | 15, 16    |
| Performance limits                 | 17 ... 22 |
| Dimensions                         | 23 ... 27 |
| Electrical connections, assignment | 28, 29    |
| Accessories                        | 30        |
| Project planning information       | 31        |
| Further information                | 31        |

## Ordering code

|    |           |           |    |           |    |    |          |    |    |    |    |    |    |    |    |    |
|----|-----------|-----------|----|-----------|----|----|----------|----|----|----|----|----|----|----|----|----|
| 01 | 02        | 03        | 04 | 05        | 06 | 07 | 08       | 09 | 10 | 11 | 12 | 13 | 14 | 15 | 16 | 17 |
|    | <b>WE</b> | <b>10</b> |    | <b>5X</b> | /  |    | <b>E</b> |    |    |    | /  |    |    |    |    | *  |

|    |  |                        |
|----|--|------------------------|
| 01 | 3 main ports   | <b>3</b>               |
|    | 4 main ports   | <b>4</b>               |
| 02 | Directional valve  | <b>WE</b>              |
| 03 | Size 10  | <b>10</b>              |
| 04 | Symbols; possible version see page 8 and 9   |                        |
| 05 | Component series 50 ... 59 (50 ... 59: unchanged installation and connection dimensions) | <b>5X</b>              |
| 06 | <b>With</b> spring return  | <b>no code</b>         |
|    | <b>With</b> reinforced compression spring (for quick switching off)                      | <b>D</b>               |
|    | <b>Without</b> spring return   | <b>O</b>               |
|    | <b>Without</b> spring return with detent   | <b>OF<sup>1)</sup></b> |
| 07 | High-power wet-pin solenoid with detachable coil   | <b>E</b>               |

## Electrical voltages

|    |                                    |                 |
|----|------------------------------------|-----------------|
| 08 | For ordering code see page 4 ... 7 | e.g. <b>G24</b> |
|----|------------------------------------|-----------------|

Manual override<sup>2)</sup> (see page 25)

|    |   |                           |
|----|---|---------------------------|
| 09 | <b>Without</b> manual override                                      | <b>no code</b>            |
|    | <b>With</b> lockable manual override "mushroom button" (large)      | <b>N5<sup>1; 3)</sup></b> |
|    | <b>With</b> manual override "mushroom button" (large), not lockable | <b>N6<sup>1)</sup></b>    |
|    | <b>With</b> concealed manual override and protective cap            | <b>N8<sup>1; 4)</sup></b> |
|    | <b>With</b> concealed manual override (standard)                    | <b>N9</b>                 |

## Corrosion resistance (outside) (for the availability, refer to the table on page 3)

|    |  |                |
|----|--|----------------|
| 10 | None (valve housing primed)  | <b>no code</b> |
|    | Improved corrosion protection (240 h salt spray test according to EN ISO 9227) | <b>J3</b>      |

## Electrical connection

|    |  |                |
|----|--|----------------|
| 11 | <b>Individual connection or central connection</b> |                |
|    | For ordering code see page 4 ... 7                 | e.g. <b>K4</b> |

## Switching time increase

|                 |   |                |              |              |              |              |              |
|-----------------|---|----------------|--------------|--------------|--------------|--------------|--------------|
| 12              | <b>Without</b> switching time increase  | <b>no code</b> |              |              |              |              |              |
|                 | <b>With</b> switching time increase (only with symbol ".73"; not for version "D" with reinforced compression spring; more information upon request) | <b>A12</b>     |              |              |              |              |              |
| 13              | <b>Without</b> throttle insert (standard)   | <b>no code</b> |              |              |              |              |              |
|                 | <b>With</b> throttle insert (when the admissible valve performance limit is exceeded, refer to page 17 and 22) <sup>5)</sup>                        |                |              |              |              |              |              |
|                 | Port  |                |              |              |              |              |              |
|                 |   | 0.8 [0.031]    | 1.0 [0.039]  | 1.2 [0.047]  | 2.0 [0.079]  | 3.0 [0.120]  | 4.0 [0.160]  |
|                 | P   | = <b>B08</b>   | = <b>B10</b> | = <b>B12</b> | = <b>B20</b> | = <b>B30</b> | = <b>B40</b> |
|                 | A   | = <b>H08</b>   | = <b>H10</b> | = <b>H12</b> | = <b>H20</b> | = <b>H30</b> | = <b>H40</b> |
|                 | B   | = <b>R08</b>   | = <b>R10</b> | = <b>R12</b> | = <b>R20</b> | = <b>R30</b> | = <b>R40</b> |
| A and B         | = <b>N08</b>  | = <b>N10</b>   | = <b>N12</b> | = <b>N20</b> | = <b>N30</b> | = <b>N40</b> |              |
| T <sup>6)</sup> | = <b>X08</b>  | = <b>X10</b>   | = <b>X12</b> | = <b>X20</b> | = <b>X30</b> | = <b>X40</b> |              |

## Ordering code

|    |           |           |    |           |    |    |          |    |    |    |    |    |    |    |    |    |
|----|-----------|-----------|----|-----------|----|----|----------|----|----|----|----|----|----|----|----|----|
| 01 | 02        | 03        | 04 | 05        | 06 | 07 | 08       | 09 | 10 | 11 | 12 | 13 | 14 | 15 | 16 | 17 |
|    | <b>WE</b> | <b>10</b> |    | <b>5X</b> | /  |    | <b>E</b> |    |    |    | /  |    |    |    |    | *  |

### Control spool play

|    |   |                |
|----|---|----------------|
| 14 | Standard (recommended)  | <b>no code</b> |
|    | Minimum (selection for reduced leakage values; higher oil cleanliness required)   | <b>T06</b>     |
|    | Increased (selection with high temperature difference hydraulic fluid/environment; leads to higher internal leakage values) | <b>T12</b>     |

### Seal material (observe compatibility of seals with hydraulic fluid used, see page 12)

|    |   |                         |
|----|---|-------------------------|
| 15 | NBR seals   | <b>M</b>                |
|    | FKM seals   | <b>V</b>                |
|    | Recommended for operation with HFC hydraulic fluids                   | <b>MH</b>               |
|    | Low-temperature version (only with version "Without manual override") | <b>MT</b>               |
| 16 | Standard  | <b>no code</b>          |
|    | Approval according to CSA C22.2 No. 139-13                            | <b>CSA</b>              |
|    | Porting pattern according to ANSI B93.9                               | <b>AN</b> <sup>7)</sup> |
| 17 | Further details in the plain text                                     | <b>*</b>                |

- 1) Only direct voltage "G..."
- 2) Operation of the manual override only possible up to 50 bar [725 psi] tank pressure. Avoid damage to the bore of the manual override. (Special tool for the operation, separate order, material no. **R900024943**). If the manual override is blocked, operation of the opposite solenoid is to be excluded. The manual override cannot be allocated a safety function.
- 3) With tank pressures higher than 50 bar, it is not guaranteed that the valve remains in the position into which it was switched by the lockable manual override ("N5").
- 4) Protective cap must be removed prior to actuation.
- 5) Not with low-temperature version "MT".
- 6) When throttle inserts are used in channel T, the pressure in the working ports and in case of connection to the tank chambers must not exceed 210 bar.
- 7) With power supply to
  - ▶ solenoid "a", channel P is connected to A
  - ▶ solenoid "b", channel P is connected to B



#### Notice:

For directional spool valves NG10 with spool position monitoring, see data sheet 23352.

### Available corrosion resistance

|      | Electrical connection<br>"DL", "DL2", "DJL" |       |       |        |        |       |         | Manual override |      |
|------|---|-------|-------|--------|--------|-------|---------|-----------------|------|
|      | "G12"                                       | "G24" | "G96" | "G110" | "G205" | "220" | "W200R" | Without         | "N8" |
| "J3" | ✓   | ✓     | ✓     | ✓      | ✓      | ✓     | ✓       | ✓               | ✓    |

**Ordering code:** DC voltage – individual connection**Electrical connections and available voltages**

(Special voltages available upon request)

| Connector  | Ordering code  | Electrical voltages     |                 |                 |                 |      |       |       |       |                 |                 | Protection class according to DIN EN 60529 <sup>1)</sup> | Protection class according to VDE 0580 |
|--|--|-------------------------|-----------------|-----------------|-----------------|------|-------|-------|-------|-----------------|-----------------|--|--|
|  |  | 12 V                    | 24 V            | 26 V            | 48 V            | 96 V | 110 V | 125 V | 180 V | 205 V           | 220 V           |  |  |
|  |  | G12                     | G24             | G26             | G48             | G96  | G110  | G125  | G180  | G205            | G220            |  |  |
| Connector 3-pole (2 + PE) according to DIN EN 175301-803                                 | <ul style="list-style-type: none"> <li>▶ Standard</li> <li>▶ With potted-in plug base and sealing element</li> </ul> | <b>K4</b>               | ✓               | ✓               | -               | ✓    | ✓     | ✓     | ✓     | ✓ <sup>4)</sup> | ✓ <sup>4)</sup> | IP65   | I <sup>2)</sup>                        |
|  |  | <b>K4K<sup>5)</sup></b> | ✓ <sup>4)</sup> | ✓ <sup>4)</sup> | ✓ <sup>4)</sup> | -    | -     | -     | -     | -               | -               | IP65   | I <sup>2)</sup>                        |
| Connector, 4-pole, M12x1 according to DIN EN 61076-2-101 with suppressor diode, coding A | ▶ Pin assignment according to DESINA   | <b>K72L</b>             | -               | ✓ <sup>4)</sup> | -               | -    | -     | -     | -     | -               | -               | IP65   | III <sup>3)</sup>                      |
| Connector 2-pole (Junior-Timer type)   | ▶ Connector radial to the valve axis   | <b>C4Z</b>              | -               | -               | ✓ <sup>4)</sup> | -    | -     | -     | -     | -               | -               | IP66   | III <sup>3)</sup>                      |

**Maximum admissible overvoltages according to DIN EN 60664-1:2008-01 (VDE 0110-1) (overvoltage category II):**

|  | in V | 12   | 24   | 26   | 48   | 96   | 110  | 125  | 180  | 205  | 220  |
|--|------|------|------|------|------|------|------|------|------|------|------|
| Nominal voltage $U_{Nom}$  | in V | 12   | 24   | 26   | 48   | 96   | 110  | 125  | 180  | 205  | 220  |
| Rated current $I_{Nom}$  | in A | 3.44 | 1.61 | 1.51 | 0.86 | 0.44 | 0.38 | 0.33 | 0.26 | 0.21 | 0.19 |
| Maximum admissible switch-off overvoltage according to VDE 0580      | in V | 500  | 500  | 500  | 500  | 500  | 500  | 500  | 500  | 500  | 500  |
| Recommended interference protection circuit with 2 x nominal voltage | in V | 24   | 48   | 52   | 96   | 192  | 220  | 250  | 360  | 410  | 440  |

- 1) Only with correctly mounted valve with a mating connector suitable for the protection class.
- 2) Protection class I with properly connected protective grounding conductor (PE) and valve mounting surface connected to the protective grounding conductor system.
- 3) With protection class III, a protective extra-low voltage with safety transformer (PELV, SELV) is to be provided.
- 4) Solenoid coils without "Recognized component" according to UL 429
- 5) Recommended for mobile applications; with additional sealing between solenoid coil and pole tube.

**Notice:**

Solenoid valves induce voltage peaks during switch-off. In order to prevent electro-magnetic interference at the system and damage to the valve control, an interference protection circuit has to be provided on the system side. Alternatively, you can also select a connector with integrated interference protection circuit.

**Ordering code:** Direct voltage – central connection**Electrical connections and available voltages**

(Special voltages available upon request)

|  | Ordering code       | Electrical voltages |      |      |       |       |       | Protection class according to DIN EN 60529 <sup>1)</sup> | Protection class according to VDE 0580 |
|--|---------------------|---------------------|------|------|-------|-------|-------|--|--|
|  |                     | 12 V                | 24 V | 96 V | 110 V | 205 V | 220 V |  |  |
|  |                     | G12                 | G24  | G96  | G110  | G205  | G220  |  |  |
| <b>Connector</b>   |                     |                     |      |      |       |       |       |  |  |
| Cable gland, terminal area 6 ... 12 mm [0.23 ... 0.47 inch] ▶ With indicator light                                 | DL <sup>6)</sup>    | ✓                   | ✓    | ✓    | ✓     | ✓     | ✓     | IP65   | I <sup>2)</sup>                        |
| Cable gland, threaded connection 1/2"-14 NPT ▶ With indicator light  | DAL                 | ✓                   | ✓    | ✓    | ✓     | ✓     | ✓     | IP65 <sup>7)</sup>                                       | I <sup>2)</sup>                        |
| Cable gland at the cover ▶ With indicator light and cable bridge at the ground connection                          | DJL <sup>6)</sup>   | ✓                   | ✓    | ✓    | ✓     | ✓     | ✓     | IP65   | I <sup>2)</sup>                        |
| Connector 7-pole (6 + PE) according to DIN EN 175201-804 ▶ With indicator light                                    | DK6L <sup>8)</sup>  | ✓                   | ✓    | ✓    | ✓     | ✓     | ✓     | IP65   | I <sup>2)</sup>                        |
| Connector according to ANSI/B93.55M-1981 (Brad Harrison Mini-Change) ▶ With indicator light, 5-pole                | DK25L <sup>8)</sup> | ✓                   | ✓    | ✓    | ✓     | ✓     | ✓     | IP65   | I <sup>2)</sup>                        |
| <b>Maximum admissible overvoltages according to DIN EN 60664-1:2008-01 (VDE 0110-1) (overvoltage category II):</b> |                     |                     |      |      |       |       |       |  |  |
| Nominal voltage $U_{Nom}$  | in V                | 12                  | 24   | 96   | 110   | 205   | 220   |  |  |
| Rated current $I_{Nom}$  | in A                | 3.44                | 1.61 | 0.44 | 0.38  | 0.21  | 0.19  |  |  |
| Maximum admissible switch-off overvoltage according to VDE 0580  | in V                | 500                 | 500  | 500  | 500   | 500   | 500   |  |  |
| Recommended interference protection circuit with 2 x nominal voltage   | in V                | 24                  | 48   | 192  | 220   | 410   | 440   |  |  |

- 1) Only with correctly mounted valve with a mating connector suitable for the protection class or suitable conduit system.
- 2) Protection class I with properly connected protective grounding conductor (PE) and valve mounting surface connected to the protective grounding conductor system.
- 3) With protection class III, a protective extra-low voltage with safety transformer (PELV, SELV) is to be provided.
- 6) Possible with version "J3".
- 7) Only with professionally designed connection with appropriate sealing to the central connection frame.
- 8) Connector pin assignment see page 29

**Ordering code:** Alternating voltage – individual connection**Electrical connections and available voltages**

(Special voltages available upon request)

| Connector  | Ordering code | Electrical voltages |                |             |             |                |                |                | Protection class according to DIN EN 60529 <sup>1)</sup> | Protection class according to VDE 0580 |
|--|---------------|---------------------|----------------|-------------|-------------|----------------|----------------|----------------|--|--|
|  |               | 100 V 50/60 Hz      | 110 V 50/60 Hz | 120 V 60 Hz | 120 V 60 Hz | 200 V 50/60 Hz | 230 V 50/60 Hz | 230 V 50/60 Hz |  |  |
|  |               | G96                 | G96            | G110        | W120        | G180           | G205           | W230           |  |  |
| Connector 3-pole (2 + PE) according to DIN EN 175301-803   | K4            | ✓                   | ✓              | ✓           | ✓           | ✓              | ✓              | ✓              | IP65   | I <sup>2)</sup>                        |
| Rectifier required (see page 30)   |               | ✓                   | ✓              | ✓           | -           | ✓              | ✓              | -              |  |  |
| <b>Maximum admissible overvoltages according to DIN EN 60664-1:2008-01 (VDE 0110-1) (overvoltage category II):</b> |               |                     |                |             |             |                |                |                |  |  |
| Nominal voltage $U_{Nom}$  | in V          | 100                 | 110            | 120         | 120         | 200            | 230            | 230            |  |  |
| Rated current $I_{Nom}$  | ▶ 50 Hz       | in A                | 0.41           | 0.45        | -           | -              | 0.26           | 0.21           | 0.43   |  |
|  | ▶ 60 Hz       | in A                | 0.41           | 0.45        | 0.37        | 0.65           | 0.26           | 0.21           | 0.32   |  |
| Lower rated current $I_1$  | ▶ 50 Hz       | in A                | -              | -           | -           | -              | -              | -              | 0.50   |  |
|  | ▶ 60 Hz       | in A                | -              | -           | -           | 0.75           | -              | -              | 0.37   |  |
| Upper rated current $I_2$  | ▶ 50 Hz       | in A                | -              | -           | -           | -              | -              | -              | 0.90   |  |
|  | ▶ 60 Hz       | in A                | -              | -           | -           | 1.20           | -              | -              | 0.60   |  |
| Maximum admissible switch-off overvoltage according to VDE 0580  | in V          | 500                 | 500            | 500         | 500         | 500            | 500            | 500            |  |  |
| Recommended interference protection circuit with 2 x nominal voltage   | in V          | 200                 | 220            | 240         | 240         | 400            | 460            | 460            |  |  |

<sup>1)</sup> Only with correctly mounted valve with a mating connector suitable for the protection class.

<sup>2)</sup> Protection class I with properly connected protective grounding conductor (PE) and valve mounting surface connected to the protective grounding conductor system.

**Notice:**

- ▶ Solenoid valves induce voltage peaks during switch-off. In order to prevent electro-magnetic interference at the system and damage to the valve control, an interference protection circuit has to be provided on the system side. Alternatively, you can also select a connector with integrated interference protection circuit.
- ▶ Dependent on the rated current  $I_{Nom}$ , circuit breakers according to tripping characteristic "K" are to be provided. Within a time interval of 0.6s, the tripping current must be 8 to 10 times the nominal power supply. The required non-tripping current of the fuse must not fall below the "lower rated current" value  $I_1$  (see table above). The maximum tripping current must not exceed the "upper rated current" value  $I_2$  (see table above). The temperature dependence of the tripping behavior of the circuit breakers has to be observed according to the manufacturer's specifications.

**Ordering code:** Alternating voltage – central connection**Electrical connections and available voltages**

(Special voltages available upon request)

| Connector  |  | Ordering code | Electrical voltages |             |             |                | Protection class according to DIN EN 60529 <sup>1)</sup> | Protection class according to VDE 0580 |
|--|--|---------------|---------------------|-------------|-------------|----------------|--|--|
|  |  |               | 110 V 50/60 Hz      | 120 V 60 Hz | 120 V 60 Hz | 230 V 50/60 Hz |  |  |
|  |  |               | W110R               | W120R       | W120        | W230R          |  |  |
| Cable gland, terminal area 6 ... 12 mm   | ▶ With indicator light   | DL            | ✓                   | ✓           | ✓           | ✓              | IP65   | I <sup>2)</sup>                        |
|  | ▶ With indicator light and interference protection circuit <sup>3)</sup> | DJL           | -                   | -           | -           | -              | IP65   | I <sup>2)</sup>                        |
| Cable gland, threaded connection 1/2"-14 NPT   | ▶ With indicator light   | DAL           | ✓                   | ✓           | ✓           | ✓              | IP65   | I <sup>2)</sup>                        |
| Connector 7-pole (6 + PE) according to DIN EN 175201-804   | ▶ With indicator light   | DK6L          | ✓                   | ✓           | ✓           | ✓              | IP65   | I <sup>2)</sup>                        |
| Connector according to ANSI/B93.55M-1981 (Brad Harrison Mini-Change)   | ▶ With indicator light, 5-pole   | DK25L         | ✓                   | ✓           | ✓           | -              | IP65   | I <sup>2)</sup>                        |
| <b>Maximum admissible overvoltages according to DIN EN 60664-1:2008-01 (VDE 0110-1) (overvoltage category II):</b> |  |               |                     |             |             |                |  |  |
| Nominal voltage $U_{Nom}$  |  | in V          | 110                 | 120         | 120         | 230            |  |  |
| Rated current $I_{Nom}$  | ▶ 50 Hz  | in A          | 0.45                | 0.37        | -           | 0.21           |  |  |
|  | ▶ 60 Hz  | in A          | 0.45                | 0.37        | 0.65        | 0.21           |  |  |
| Lower rated current $I_1$  | ▶ 50 Hz  | in A          | -                   | -           | -           | -              |  |  |
|  | ▶ 60 Hz  | in A          | -                   | -           | 0.75        | -              |  |  |
| Upper rated current $I_2$  | ▶ 50 Hz  | in A          | -                   | -           | -           | -              |  |  |
|  | ▶ 60 Hz  | in A          | -                   | -           | 1.20        | -              |  |  |
| Maximum admissible switch-off overvoltage according to VDE 0580  |  | in V          | 500                 | 500         | 500         | 500            |  |  |
| Recommended interference protection circuit with 2 x nominal voltage   |  | in V          | -                   | -           | 240         | -              |  |  |

- 1) Only with correctly mounted valve with a mating connector suitable for the protection class or suitable conduit system.
- 2) Protection class I with properly connected protective grounding conductor (PE) and valve mounting surface connected to the protective grounding conductor system.
- 3) Wire bridge between pin 2- and 4-.

**Notice:**

- ▶ Solenoid valves induce voltage peaks during switch-off. In order to prevent electro-magnetic interference at the system and damage to the valve control, an interference protection circuit has to be provided on the system side. For valves with integrated rectifier ("W...R"), no protection circuit on the system side is required. The rectifier in the valve completes this function.
- ▶ Dependent on the rated current  $I_{Nom}$ , circuit breakers according to tripping characteristic "K" are to be provided. Within a time interval of 0.6s, the tripping current must be 8 to 10 times the nominal power supply. The required non-tripping current of the fuse must not fall below the "lower rated current" value  $I_1$  (see table above). The maximum tripping current must not exceed the "upper rated current" value  $I_2$  (see table above). The temperature dependence of the tripping behavior of the circuit breakers has to be observed according to the manufacturer's specifications.

### Symbols

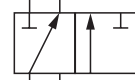
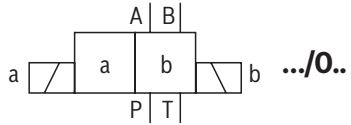
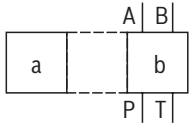
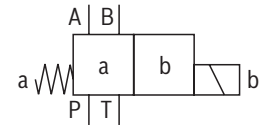
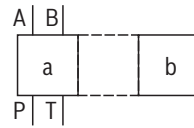
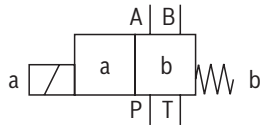
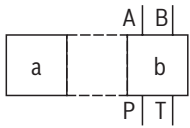

**B**  
**B73**

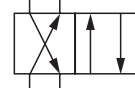
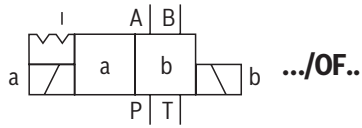
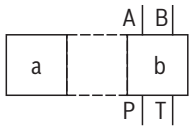

**Y**  
**Y73**

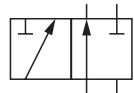

**A**  
**A73**

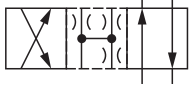

**C**

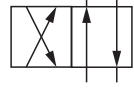
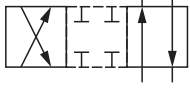

**D**  
**D73**

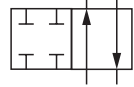

**X7**



**Notice:**

Representation according to DIN ISO 1219-1.  
Hydraulic interim positions are shown by dashes.



### Symbols

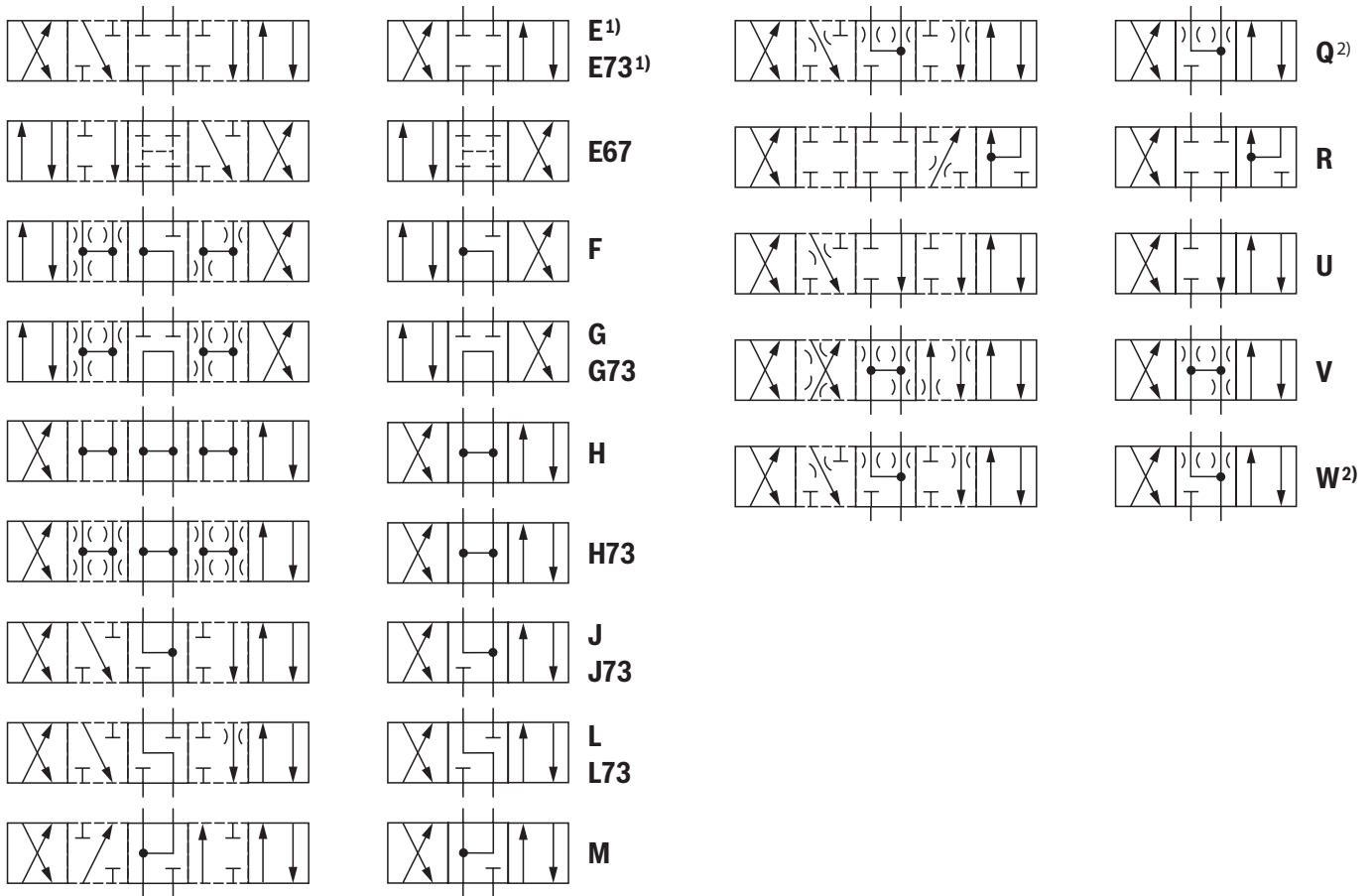
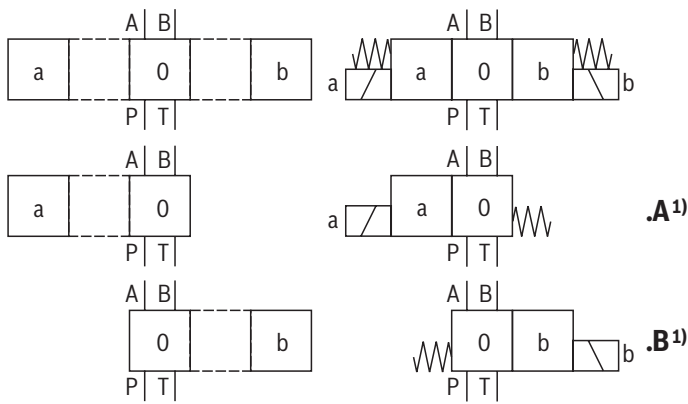

- 1) **Example:**
- ▶ Symbol E with spool position "a" ordering code **..EA..**
  - ▶ Symbol E with spool position "b" ordering code **..EB..**
- 2) Flow cross-section see page 11.

**Notice:**

- ▶ Representation according to DIN ISO 1219-1.
- Hydraulic interim positions are shown by dashes.
- ▶ Other symbols upon request.

## Function, section

The directional valves of type WE are solenoid-actuated directional spool valves that can be used as electro-hydraulic component. They control the start, stop and direction of a flow.

The directional valves basically consist of the housing (1), one or two electronic solenoids (2), the control spool (3), and the return springs (4).

In the de-energized condition, the control spool (3) is held in the central position or in the initial position by the return springs (4) (except for version "O").

If the wet-pin electronic solenoid (2) is supplied with power, the control spool (3) moves out of its rest position into the required end position. In this way, the required direction of flow according to the selected symbol is released.

After the electronic solenoid (2) has been switched off, the control spool (3) is pushed back into its central position or into its initial position (except for valves with "OF" detent and valves without type "O" spring).

A manual override (5) allows for the manual switching of the valve without solenoid energization.

**For unobjectionable functioning, the hydraulic system has to be bled properly.**

**Without spring return "O"** (only possible with symbols A, C and D)

This version is a directional valve with two spool positions and two electronic solenoids **without** detent. The valve without spring return at the control spool (3) has no defined basic position in the de-energized condition.

**Without spring return with "OF" detent** (only possible with symbols A, C and D)

This version is a directional valve with two spool positions and two electronic solenoids **with** detent. The detents are used to fix the control spool (3) in the relevant spool position. During operation, continuous application of current to the electronic solenoid can thus be omitted which contributes to energy-efficient operation.

**Version ".73...A12"** (smooth switching behavior)

By means of structural design of the control spools and solenoids, switching shocks occurring when activating and deactivating the valves are significantly reduced.

The switching shocks, measured as acceleration values **a**, can be reduced by up to approx. 85% when compared to the standard valve depending on the design of the control spool (for this, see "Acceleration values" on page 14).

### Notice:

Pressure peaks in the tank line to two or several valves can result in unintended movements of the control spool in the case of version with detent. We therefore recommend that separate return lines be provided or a check valve installed in the tank line.

Due to the design principle, internal leakage is inherent to the valves, which may increase over the life cycle.

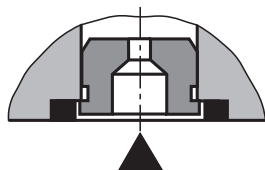
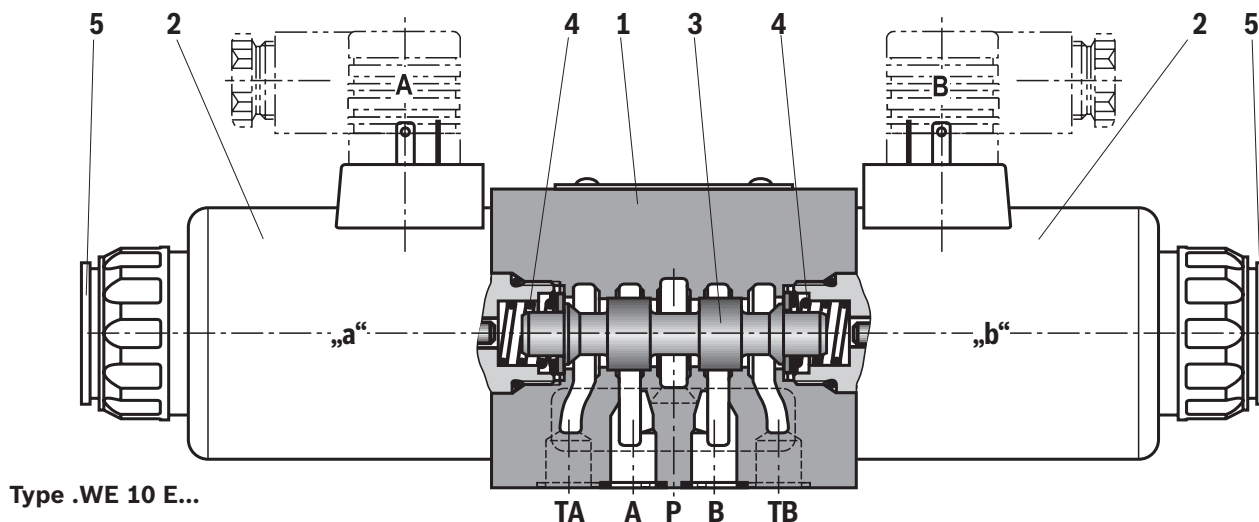

### Throttle insert

The use of a throttle insert is required when, due to prevailing operating conditions, flows occur during the switching processes which exceed the performance limit of the valve.

**Technical data**

(for applications outside these values, please consult us!)

| <b>General</b>   |  |   |  |   |            |
|--|--|---|--|---|------------|
| Weight   |  | Individual connection                   |  | Central connection  |            |
|  |  | ▶ Valve with one solenoid               | kg [lbs]   | 3.9 [8.6]   | 4.0 [8.8]  |
|  |  | ▶ Valve with two solenoids              | kg [lbs]   | 5.5 [12.1]  | 5.6 [12.3] |
| Installation position  |  |   | any <sup>1)</sup>                                    |   |            |
| Ambient temperature range  |  | ▶ Standard version                      |  | °C [°F] -20 ... +70 [-4 ... +158] (NBR seals)<br>-15 ... +70 [+5 ... +158] (FKM seals)  |            |
|  |  | ▶ Version for HFC hydraulic fluid       |  | °C [°F] -20 ... +50 [-4 ... +122]   |            |
|  |  | ▶ Low-temperature version <sup>2)</sup> |  | °C [°F] -40 ... +50 [-40 ... +122]  |            |
| Storage temperature range  |  |   | °C [°F] +5 ... +40 [41 ... +104]                     |   |            |
| MTTF <sub>D</sub> values according to EN ISO 13849   |  |   | Years 300 (for further details see data sheet 08012) |   |            |
| <b>Hydraulic</b>   |  |   |  |   |            |
| Maximum operating pressure <sup>2)</sup>   |  | ▶ Port A, B, P                          |  | bar [psi] 350 [5076]  |            |
|  |  | ▶ Port T <sup>3)</sup>                  |  | bar [psi] 210 [3050]; Tank pressure (standard)<br>With symbols A and B, port T must be used as leakage oil connection if the operating pressure exceeds the maximum admissible tank pressure. |            |
| Maximum flow   |  | ▶ Direct voltage DC                     |  | l/min [US gpm] 160 [42.3]   |            |
|  |  | ▶ Alternating voltage AC                |  | l/min [US gpm] 120 [31.7]   |            |
| Flow cross-section (spool position 0)  |  | ▶ Symbol Q                              |  | mm <sup>2</sup> approx. 6% of nominal cross-section   |            |
|  |  | ▶ Symbol W                              |  | mm <sup>2</sup> approx. 3% of nominal cross-section   |            |
| Hydraulic fluid  |  |   | see table below                                      |   |            |
| Hydraulic fluid temperature range (at the valve working ports)   |  |   |  | °C [°F] -20 ... +80 [-4 ... +176] (NBR seals)   |            |
|  |  |   |  | -15 ... +80 [+5 ... +176] (FKM seals)   |            |
|  |  |   |  | -20 ... +50 [-4 ... +122] (HFC hydraulic fluid)   |            |
|  |  |   |  | -40 ... +50 [-40 ... +122] (low-temperature version)  |            |
| Viscosity range  |  |   | mm <sup>2</sup> /s [SUS] 2.8 ... 500 [35 ... 2320]   |   |            |
| Maximum admissible degree of contamination of the hydraulic fluid; cleanliness class according to ISO 4406 (c) |  |   | Class 20/18/15 <sup>4)</sup>                         |   |            |

<sup>1)</sup> With suspended installation, higher sensitivity to contamination. Horizontal installation is recommended.

<sup>2)</sup> For the use at low temperatures, see Project planning information on page 31.

<sup>3)</sup> 160 bar with version "W120" and "W230".

<sup>4)</sup> The cleanliness classes specified for the components must be adhered to in hydraulic systems. Effective filtration prevents faults and simultaneously increases the life cycle of the components.

For the selection of filters, see [www.boschrexroth.com/filter](http://www.boschrexroth.com/filter).

## Technical data

(for applications outside these values, please consult us!)

| Hydraulic fluid | Classification             | Suitable sealing materials   | Standards | Data sheet |
|-----------------|----------------------------|--|-----------|------------|
| Mineral oils    | HL, HLP, HLPD, HVLP, HVLPD | NBR, FKM   | DIN 51524 | 90220      |
| Bio-degradable  | ▶ Insoluble in water       | HETG   | ISO 15380 | 90221      |
|                 |                            | HEES   |           |            |
|                 | ▶ Soluble in water         | HEPG   | ISO 15380 |            |
| Flame-resistant | ▶ Water-free               | HFDU (glycol base)   | ISO 12922 | 90222      |
|                 |                            | HFDU (ester base)  |           |            |
|                 |                            | HFDR   |           |            |
|                 | ▶ Containing water         | HFC (Fuchs: Hydrotherm 46M, Renosafe 500; Petrofer: Ultra Safe 620; Houghton: Safe 620; Union: Carbide HP5046) | ISO 12922 | 90223      |

### Important information on hydraulic fluids:

- ▶ For further information and data on the use of other hydraulic fluids, please refer to the data sheets above or contact us.
- ▶ There may be limitations regarding the technical valve data (temperature, pressure range, life cycle, maintenance intervals, etc.).
- ▶ The ignition temperature of the hydraulic fluid used must be 50 K higher than the maximum surface temperature.
- ▶ **Bio-degradable and flame-resistant – containing water:**  
If components with galvanic zinc coating (e.g. version "J3" or "J5") or parts containing zinc are used, small amounts of dissolved zinc may get into the hydraulic system and cause accelerated aging of the hydraulic fluid. Zinc soap may form as a chemical reaction product, which may clog filters, nozzles and solenoid valves - particularly in connection with local heat input.

### ▶ Flame-resistant – containing water:

- Due to increased cavitation tendency with HFC hydraulic fluids, the life cycle of the component may be reduced by up to 30% as compared to the use with mineral oil HLP. In order to reduce the cavitation effect, it is recommended - if possible specific to the installation - to back up the return flow pressure in ports T to approx. 20% of the pressure differential at the component.
- Dependent on the hydraulic fluid used, the maximum ambient and hydraulic fluid temperature must not exceed 50 °C. In order to reduce the heat input into the component, a maximum duty cycle of 50% in continuous operation has to be set for on/off valves (measuring period 300 s). If this is not possible due to the function, an energy-reducing control of these components is recommended, e.g. via a PWM plug-in amplifier.

**Technical data**

(for applications outside these values, please consult us!)

| Electric   |         |   |                              |                             |  |                             |
|--|---------|---|------------------------------|-----------------------------|--|-----------------------------|
| Voltage type   |         | Direct voltage  | Alternating voltage 50/60 Hz |                             |  |                             |
| Nominal voltage according to VDE 0580                  | V       | see page 4 and 5  | 120                          | 230                         | With central connection or via rectifier <sup>5)</sup> |                             |
| Voltage tolerance (nominal voltage)                    | %       | ±10   |                              |                             |  |                             |
| Nominal power according to VDE 0580                    | W       | 40 <sup>6)</sup>  | –                            |                             | 40   |                             |
| Holding power  | VA      | –   | 90                           |                             | –  |                             |
| Switch-on power  | VA      | –   | 550                          |                             | –  |                             |
| Duty cycle (ED)  | %       | 100 (S1 according to VDE 0580)  |                              |                             |  |                             |
| Switching time <sup>7)</sup>                           | ▶ ON    | – Pressure change 5%  | ms                           | 60 ... 104 <sup>8; 9)</sup> | 17 ... 20  | 60 ... 104 <sup>8; 9)</sup> |
|  |         | – Pressure change 95%   | ms                           | 90 ... 165 <sup>8; 9)</sup> | 48 ... 57  | 90 ... 165 <sup>8; 9)</sup> |
|  | ▶ OFF   | – Pressure change 5%  | ms                           | 12 ... 50                   | 19 ... 26  | 230 ... 330                 |
|  |         | – Pressure change 95%   | ms                           | 48 ... 104                  | 47 ... 77  | 250 ... 360                 |
| Switching time according to ISO 6403 <sup>10)</sup>    | ▶ ON    |   |                              | 45 ... 60                   | 13 ... 59  | 45 ... 60                   |
|  | ▶ OFF   |   |                              | 20 ... 30                   | 22 ... 82  | 250 ... 360                 |
| Maximum switching frequency                            | 1/s     | 4.2   | 2                            |                             | 2  |                             |
| Protection class according to DIN EN 60529             |         | see page 4 ... 7  |                              |                             |  |                             |
| Protection class according to VDE 0580                 |         | see page 4 ... 7  |                              |                             |  |                             |
| Maximum surface temperature of the coil <sup>11)</sup> | °C [°F] | 140 [284]   |                              |                             |  |                             |
| Insulation class VDE 0580                              |         | F   | F                            | H                           | F  |                             |
| Electrical protection                                  |         | Maximum admissible switch-off overvoltage see page 4 ... 7<br>Every solenoid must be protected individually, using a suitable fuse with tripping characteristics K (inductive loads). |                              |                             |  |                             |
| Protective grounding conductor and screening           |         | The valve must be installed on a surface that is included in the equipotential bonding.<br>Connector pin assignment (CE-compliant installation) see page 28 and 29                    |                              |                             |  |                             |
| Conformity   |         | CE according to Low-Voltage Directive 2014/35/EU tested according to EN 60204-1:2006-01 and DIN VDE 0580, classified as component   |                              |                             |  |                             |

<sup>5)</sup> Central connection or via rectifier:

- ▶ Mating connectors with rectifier see page 30
- ▶ Possible voltages see page 6 and 7
- ▶ Rectifiers must comply with the relevant standards as well as the coil performance data!
- ▶ With a central connection, the rectifier is on the board

<sup>6)</sup> Reduction of the nominal power by approx. 40% if a 24 V-coil with connector switching amplifier type VT-SSBA1-PWM-1X/V002/5 is used (separate order, material no. **R901290194**, see page 30 and data sheet 30362)

<sup>7)</sup> Measured with flow, 80% performance limit and horizontal installation position.

<sup>8)</sup> Not with symbols A, B and .73.

<sup>9)</sup> Reduction of the switching time by approx. 50% if a 12 V-coil with connector switching amplifier type VT-SSBA1-PWM-1X/V001/5 is used (separate order, material no. **R901265633**, see page 30 and data sheet 30362)

<sup>10)</sup> Measured without flow

<sup>11)</sup> Due to the arising **surface temperatures** of the solenoid coils, the standards ISO 13732-1 and ISO 4413 are to be observed. The specified surface temperature in AC solenoids is valid for fault-free operation. In the error case (e.g. blocking of the control spool), the surface temperature may increase above 180 °C [356 °F]. Thus, the system must be checked for possible dangers considering the ignition temperature of the hydraulic fluid used. As protection, circuit breakers (see table page 4 ... 7) must be used, unless the creation of an ignitable atmosphere can be excluded in a different way. Thus, the surface temperature can – in the error case – be limited to maximally 220 °C [428 °F]. You have to use cables that have been approved of for a working temperature of more than 90 °C [194 °F] (individual connection) and/or 105 °C [221 °F] (central connection).

## Technical data

(for applications outside these values, please consult us!)

### Notice:

- ▶ Any simultaneous actuation of 2 solenoids of one valve must be ruled out
- ▶ Due to possible overload of the board, valves with central connection must not be operated with twice the voltage.
- ▶ If the standard environmental conditions according to VDE 0580 cannot be provided, the valve must be especially protected!

### ▶ Energy saving

If directional valves with a nominal voltage of 24 V are used, a switching amplifier will reduce the continuous current considerably.

After a defined power supply time and the connected hydraulic switching of the valve, the system switches to pulse width modulation and the power is considerably reduced. This leads to a holding power under the power of a valve with 24 V supply voltage (see data sheet 30362).

### ▶ Fast switch on

For accelerated switching on the solenoid side, valves with individual connection and a nominal voltage of 12 V or 24 V can be controlled with two times the voltage for a maximum of 100 ms (pulse width modulation see data sheet 30362). In this connection, the maximum admissible switching frequency is reduced to 3 1/s.

### ▶ Dampened switching

With valves of version "A12", damping of the switch-on and switch-off process is possible (smoothly switching). In this way, switching shocks in the system are considerably reduced.

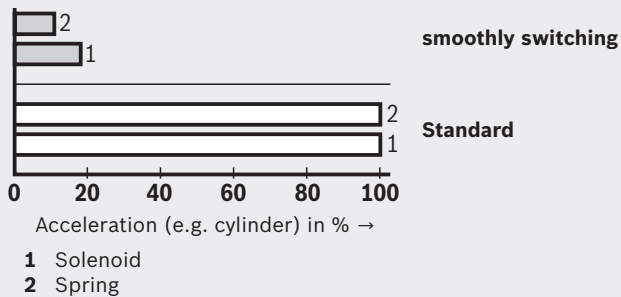

### Electrical connections and available voltages

see page 4 ... 7.

## Characteristic curves

(measured with HLP46,  $\vartheta_{oil} = 40 \pm 5 \text{ }^\circ\text{C}$  [104 ± 9 °F])

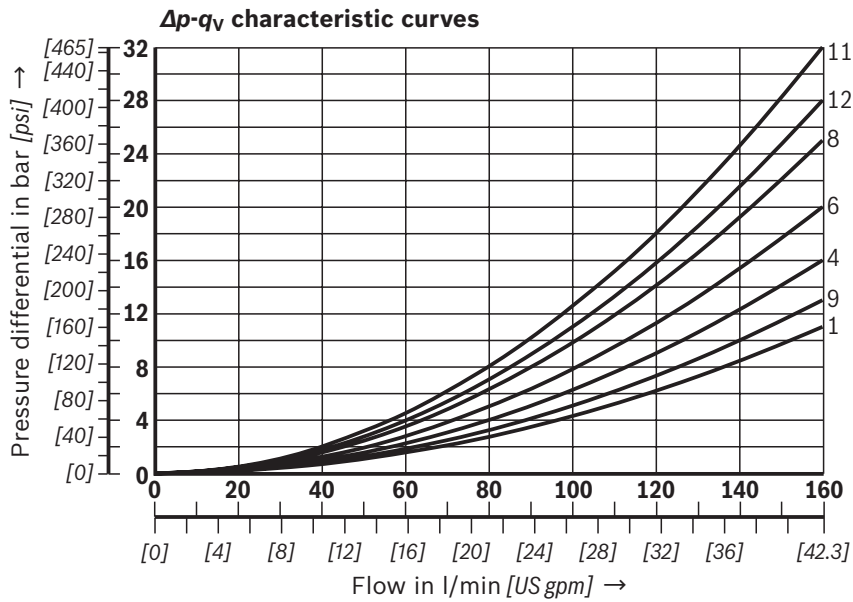

| Symbol | Direction of flow |       |       |       |
|--------|-------------------|-------|-------|-------|
|        | P - A             | P - B | A - T | B - T |
| A; B   | 5                 | 5     | -     | -     |
| C      | 1                 | 2     | 4     | 5     |
| D      | 2                 | 2     | 4     | 5     |
| E      | 3                 | 9     | 5     | 7     |
| E67    | 4                 | 4     | 12    | 11    |
| F      | 2                 | 3     | 7     | 10    |
| G      | 4                 | 4     | 11    | 11    |
| H      | 1                 | 1     | 7     | 7     |
| J      | 3                 | 3     | 7     | 12    |
| L      | 3                 | 3     | 7     | 7     |
| M      | 1                 | 1     | 5     | 5     |
| Q      | 9                 | 3     | 4     | 6     |
| R      | 4                 | 7     | 4     | 11    |
| U      | 3                 | 3     | 5     | 12    |
| V      | 3                 | 3     | 4     | 7     |
| W      | 9                 | 3     | 4     | 5     |
| X7     | 2                 | -     | -     | 6     |
| Y      | 3                 | 9     | 4     | 7     |

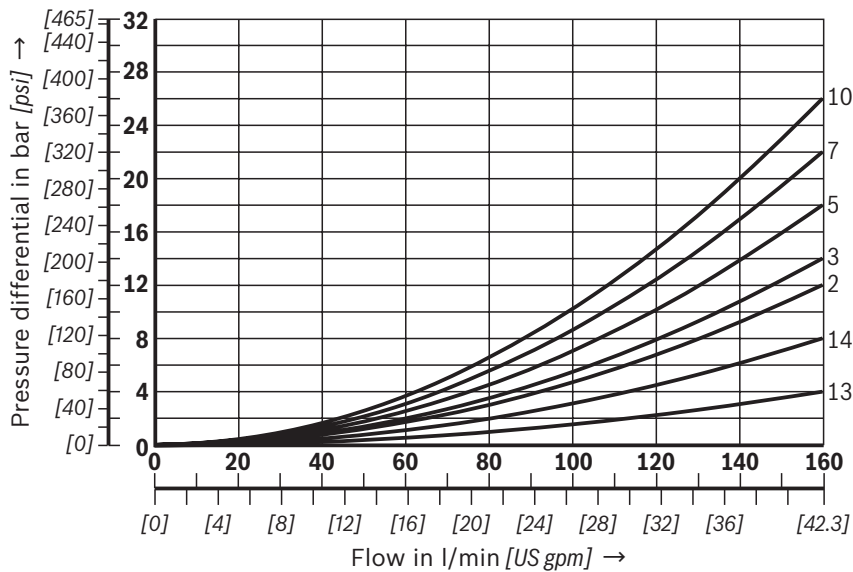

### Central position:

| Symbol | Direction of flow |       |       |       |       |
|--------|-------------------|-------|-------|-------|-------|
|        | P - A             | P - B | B - T | A - T | P - T |
| H      | 13                | 13    | 14    | 14    | 2     |

### Characteristic curves

(measured with HLP46,  $\vartheta_{oil} = 40 \pm 5 \text{ }^\circ\text{C}$  [104  $\pm$  9  $^\circ\text{F}$ ])

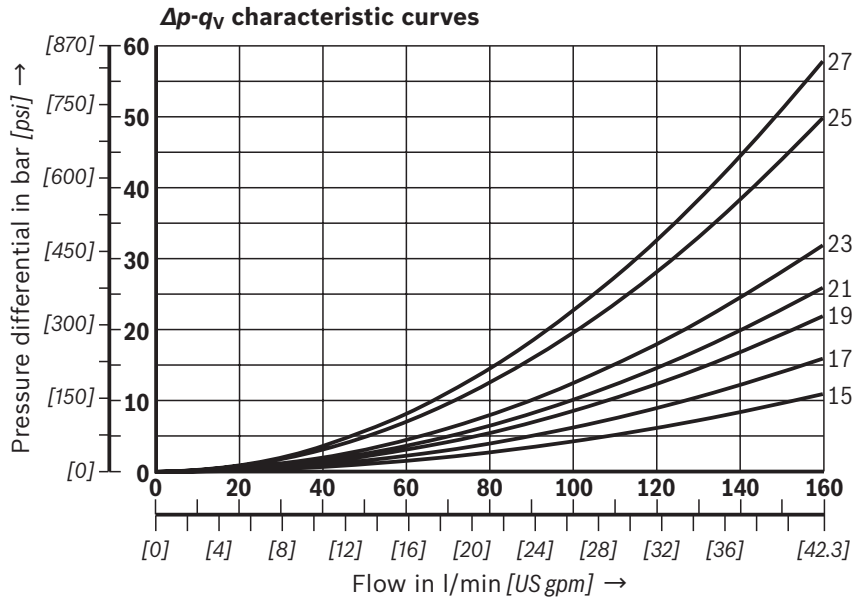

| Symbol          | Direction of flow |       |       |       |
|-----------------|-------------------|-------|-------|-------|
|                 | P - A             | P - B | A - T | B - T |
| <b>A73; B73</b> | 21                | 21    | -     | -     |
| <b>D73</b>      | 24                | 25    | 25    | 26    |
| <b>E73</b>      | 16                | 17    | 19    | 19    |
| <b>G73</b>      | 17                | 17    | 23    | 23    |
| <b>H73</b>      | 15                | 15    | 18    | 19    |
| <b>J73</b>      | 20                | 19    | 15    | 23    |
| <b>L73</b>      | 20                | 21    | 22    | 23    |
| <b>Y73</b>      | 25                | 25    | 25    | 27    |

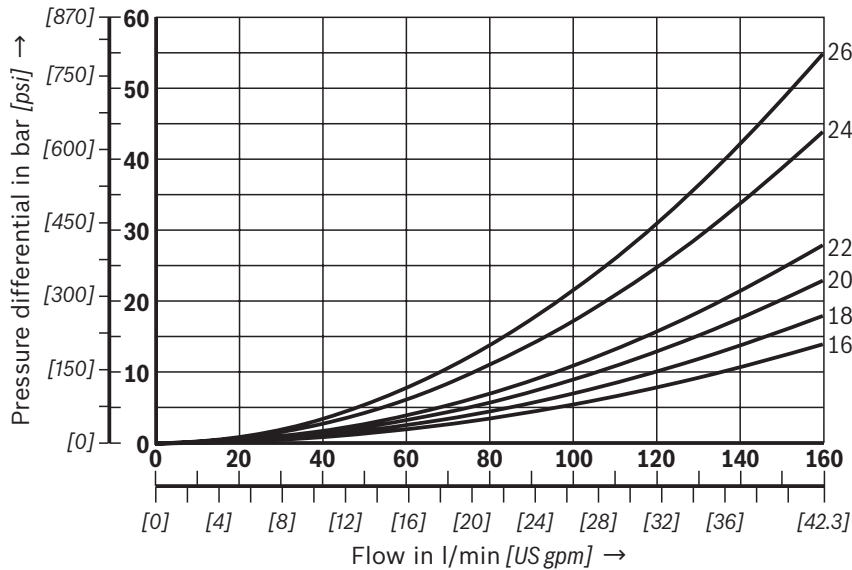



**Performance limits:** Direct voltage  
(measured with HLP46,  $\vartheta_{oil} = 40 \pm 5 \text{ }^\circ\text{C}$  [104 ± 9 °F])

**Notice:**

The specified performance limits are valid for operation with two directions of flow (e.g. from P to A and simultaneous return flow from B to T). Due to the flow forces acting within the valves, the admissible performance limit may be considerably lower

with only one direction of flow (e.g. from P to A while port B is blocked)!

In such use cases, please consult us!

**The performance limits were determined when the solenoids were at operating temperature, at 10% undervoltage and without tank preloading.**

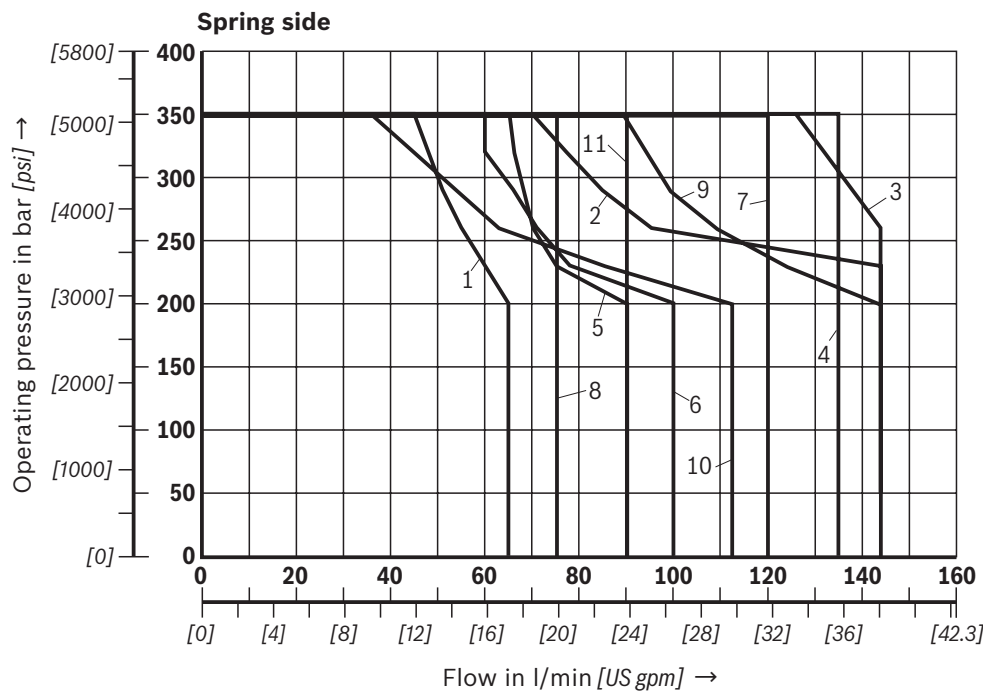

| Characteristic curve | Symbol |
|----------------------|--------|
| 1                    | A73    |
| 2                    | A/OF   |
| 3                    | D73/OF |
| 4                    | E73    |
| 5                    | F      |
| 6                    | G73    |
| 7                    | H      |
| 8                    | M      |
| 9                    | U      |
| 10                   | X7     |
| 11                   | Y      |

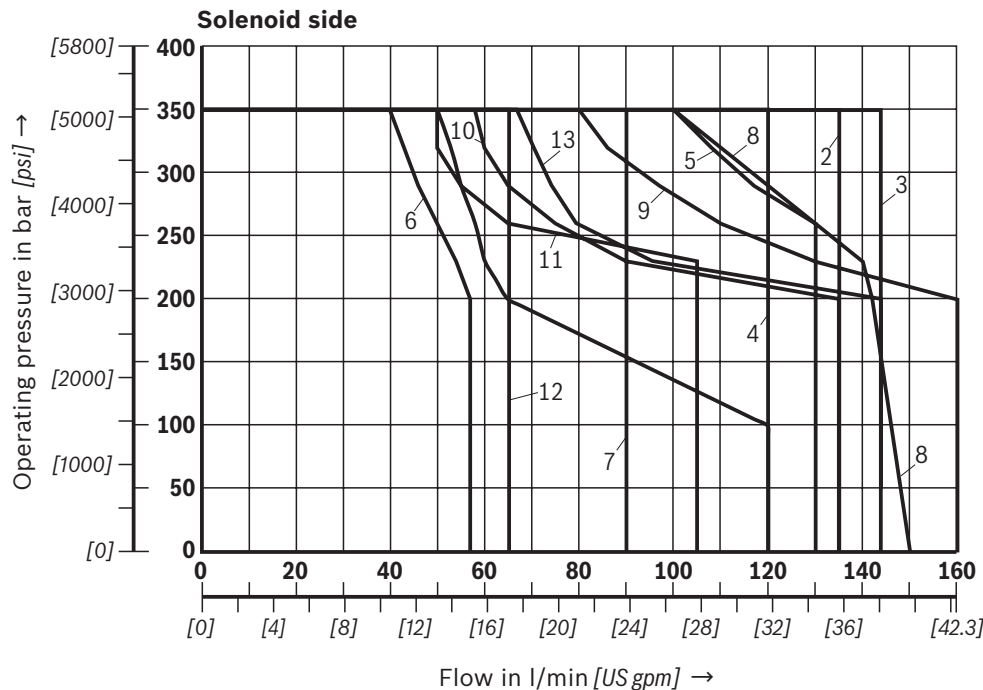

| Characteristic curve | Symbol     |
|----------------------|------------|
| 1                    | A; B       |
| 2                    | C; D       |
| 3                    | C/OF; D/OF |
| 4                    | H          |
| 5                    | E          |
| 6                    | E67        |
| 7                    | G          |
| 8                    | J          |
| 9                    | L          |
| 10                   | Q          |
| 11                   | R          |
| 12                   | V          |
| 13                   | W          |

**Performance limits:** Direct voltage  
(measured with HLP46,  $\vartheta_{oil} = 40 \pm 5 \text{ }^\circ\text{C}$  [ $104 \pm 9 \text{ }^\circ\text{F}$ ])

**Notice:**

The specified performance limits are valid for operation with two directions of flow (e.g. from P to A and simultaneous return flow from B to T).  
Due to the flow forces acting within the valves, the admissible performance limit may be considerably lower with only one direction of flow (e.g. from P to A while

port B is blocked)!

In such use cases, please consult us!

**The performance limits were determined when the solenoids were at operating temperature, at 10% undervoltage and without tank preloading.**

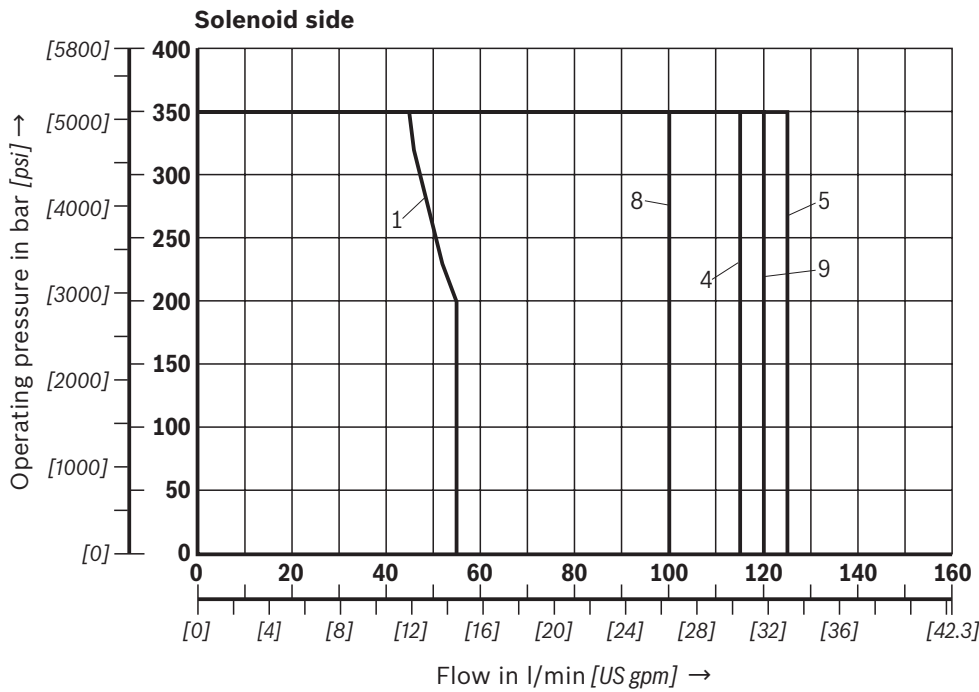

| Characteristic curve | Symbol    |
|----------------------|-----------|
| 1                    | B73       |
| 4                    | E73...A12 |
| 5                    | H73...A12 |
| 8                    | L73       |
| 9                    | Y73       |

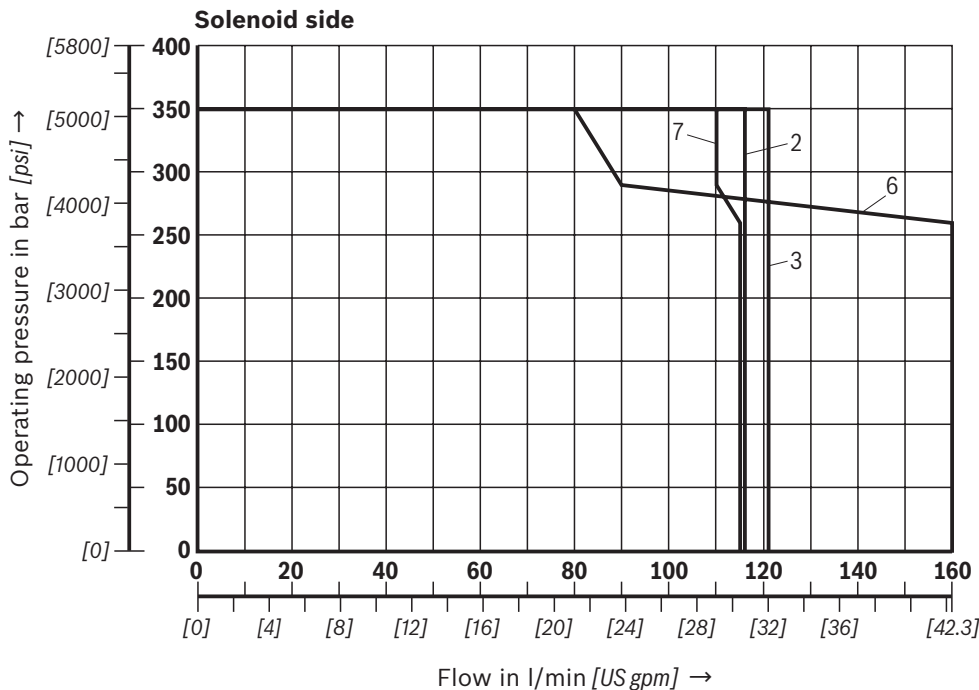

| Characteristic curve | Symbol    |
|----------------------|-----------|
| 2                    | D73       |
| 3                    | D73...A12 |
| 6                    | J73       |
| 7                    | J73...A12 |

**Performance limits:** AC voltage – 120 V 60 Hz  
(measured with HLP46,  $\vartheta_{oil} = 40 \pm 5 \text{ }^\circ\text{C}$  [104 ± 9 °F])

**Notice:**

The specified performance limits are valid for operation with two directions of flow (e.g. from P to A and simultaneous return flow from B to T). Due to the flow forces acting within the valves, the admissible performance limit may be considerably lower

with only one direction of flow (e.g. from P to A while port B is blocked)!

In such use cases, please consult us!

**The performance limits were determined when the solenoids were at operating temperature, at 10% undervoltage and without tank preloading.**

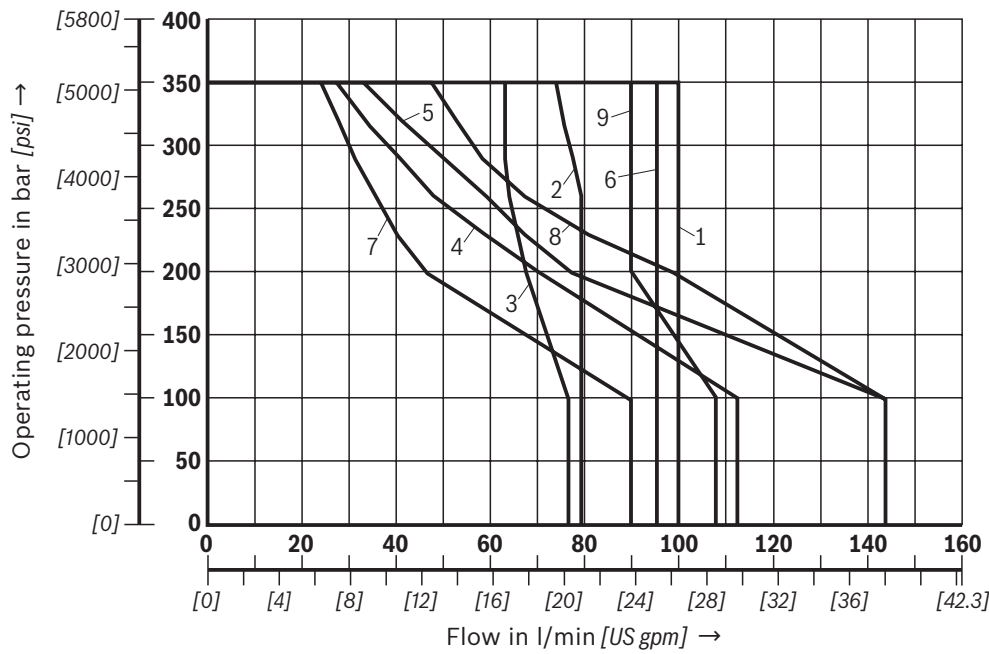

| Characteristic curve | Symbol |
|----------------------|--------|
| 1                    | D      |
| 2                    | E      |
| 3                    | G      |
| 4                    | J      |
| 5                    | A      |
| 6                    | C      |
| 7                    | L      |
| 8                    | Y      |

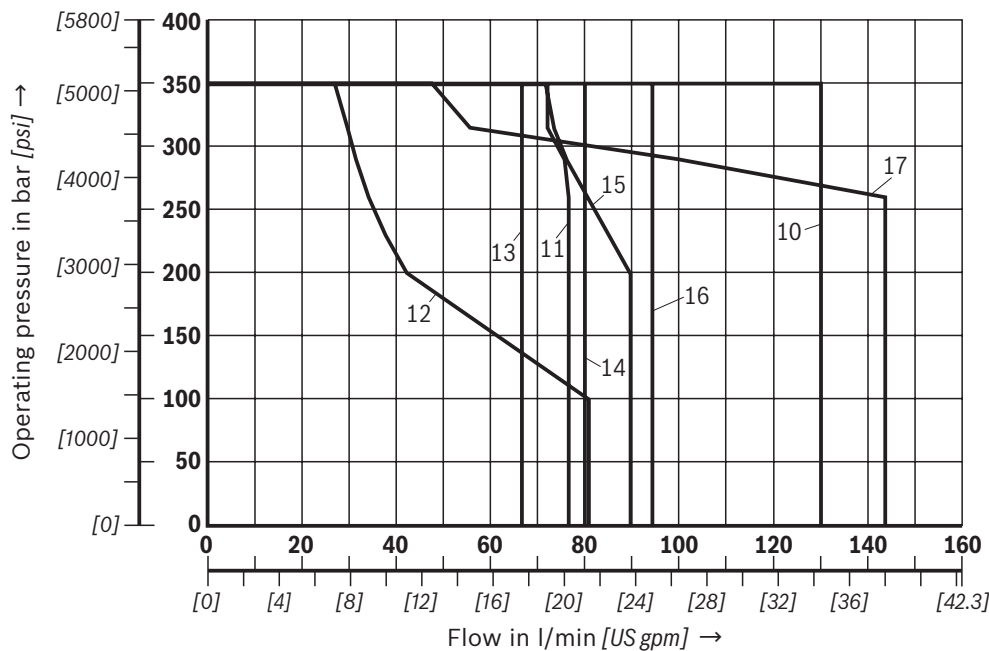

| Characteristic curve | Symbol |
|----------------------|--------|
| 10                   | EA     |
| 11                   | EB     |
| 12                   | F      |
| 13                   | HA     |
| 14                   | H73    |
| 15                   | M      |
| 16                   | Q      |
| 17                   | R      |

**Performance limits:** AC voltage – 120 V 60 Hz  
 (measured with HLP46,  $\vartheta_{oil} = 40 \pm 5 \text{ }^\circ\text{C}$  [104 ± 9 °F])

**Notice:**

The specified performance limits are valid for operation with two directions of flow (e.g. from P to A and simultaneous return flow from B to T). Due to the flow forces acting within the valves, the admissible performance limit may be considerably lower

with only one direction of flow (e.g. from P to A while port B is blocked)!

In such use cases, please consult us!

**The performance limits were determined when the solenoids were at operating temperature, at 10% undervoltage and without tank preloading.**

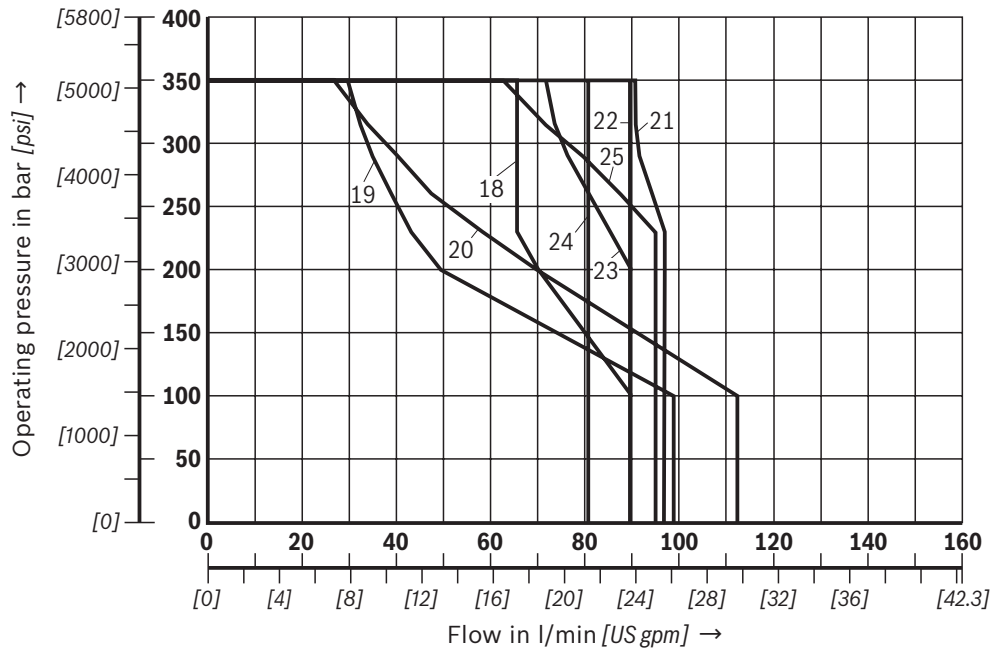

| Characteristic curve | Symbol |
|----------------------|--------|
| 18                   | GA     |
| 19                   | G73    |
| 20                   | YES    |
| 21                   | JB     |
| 22                   | LB     |
| 23                   | MA; MB |
| 24                   | U      |
| 25                   | W      |

**Performance limits:** AC voltage – 230 V 50 Hz  
(measured with HLP46,  $\vartheta_{oil} = 40 \pm 5 \text{ }^\circ\text{C}$  [104 ± 9 °F])

**Notice:**

The specified performance limits are valid for operation with two directions of flow (e.g. from P to A and simultaneous return flow from B to T).  
Due to the flow forces acting within the valves, the admissible performance limit may be considerably lower

with only one direction of flow (e.g. from P to A while port B is blocked)!

In such use cases, please consult us!

**The performance limits were determined when the solenoids were at operating temperature, at 10% undervoltage and without tank preloading.**

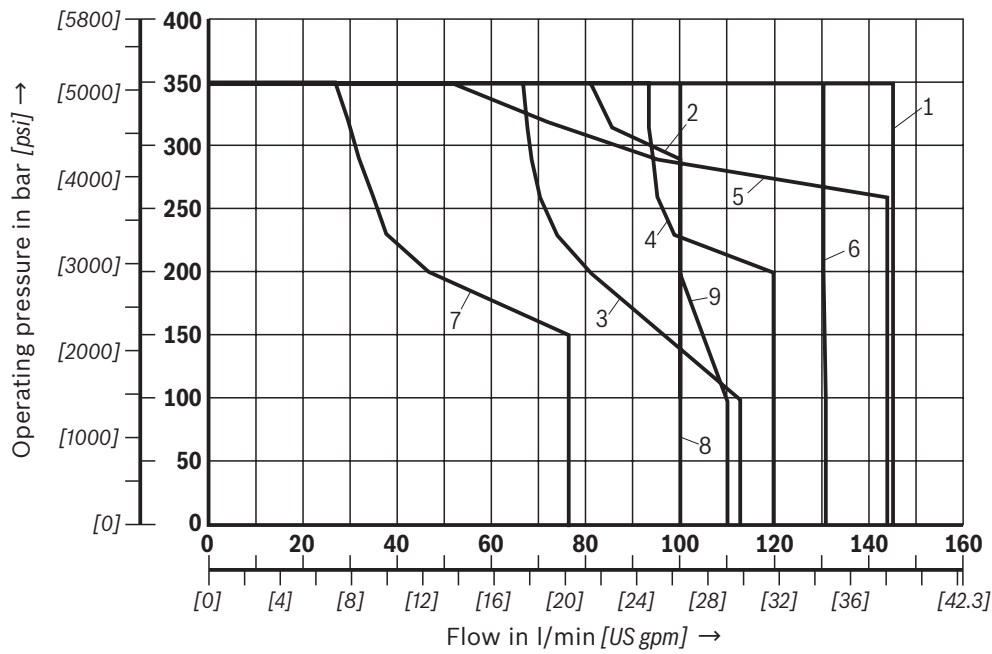

| Characteristic curve | Symbol |
|----------------------|--------|
| 1                    | D      |
| 2                    | E      |
| 3                    | G      |
| 4                    | J      |
| 5                    | A      |
| 6                    | C      |
| 7                    | L      |
| 8                    | Y      |

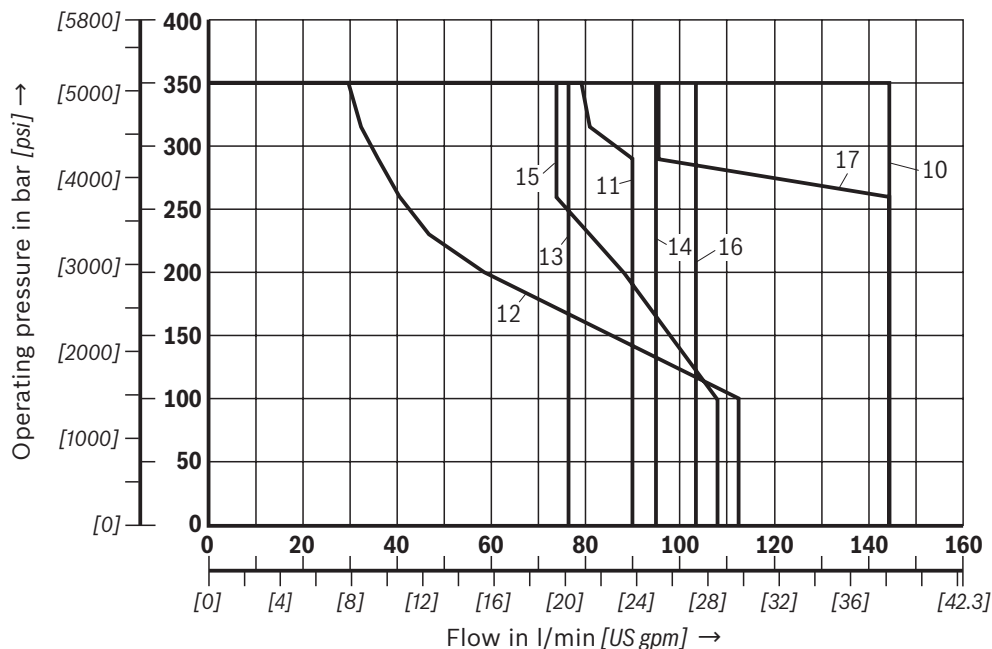

| Characteristic curve | Symbol |
|----------------------|--------|
| 10                   | EA     |
| 11                   | EB     |
| 12                   | F      |
| 13                   | HA     |
| 14                   | H73    |
| 15                   | M      |
| 16                   | Q      |
| 17                   | R      |

**Performance limits:** AC voltage – 230 V 50 Hz  
(measured with HLP46,  $\vartheta_{oil} = 40 \pm 5 \text{ }^\circ\text{C}$  [ $104 \pm 9 \text{ }^\circ\text{F}$ ])

 **Notice:**

The specified performance limits are valid for operation with two directions of flow (e.g. from P to A and simultaneous return flow from B to T).

Due to the flow forces acting within the valves, the admissible performance limit may be considerably lower

with only one direction of flow (e.g. from P to A while port B is blocked)!

In such use cases, please consult us!

**The performance limits were determined when the solenoids were at operating temperature, at 10% undervoltage and without tank preloading.**

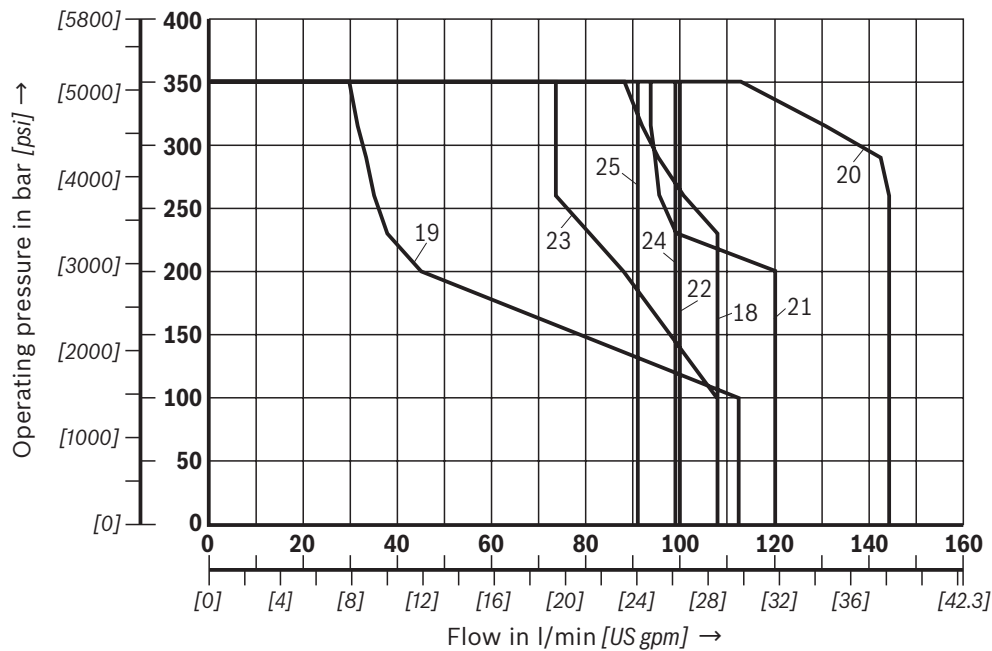

| Characteristic curve | Symbol |
|----------------------|--------|
| 18                   | GA     |
| 19                   | G73    |
| 20                   | YES    |
| 21                   | JB     |
| 22                   | LB     |
| 23                   | MA, MB |
| 24                   | U      |
| 25                   | W      |

**Dimensions:** DC voltage – individual connection  
(dimensions in mm [inch])

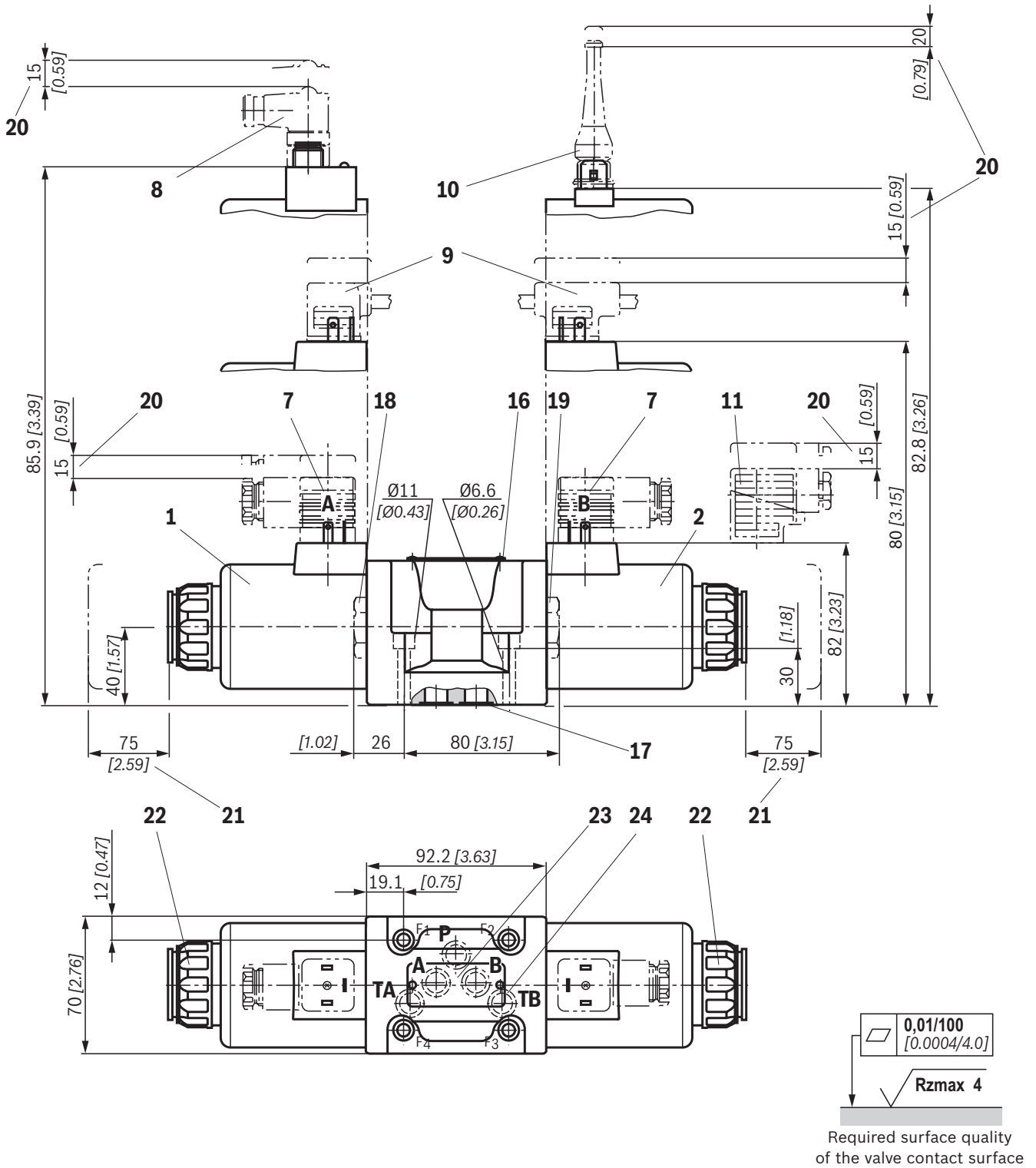

**Notice:**

- ▶ Deviating from ISO 4401, port T is called TA and port T1 is called TB in this data sheet.
- ▶ The dimensions are nominal dimensions which are subject to tolerances.

**Dimensions for manual overrides** see page 25.  
**Item explanations, valve mounting screws and subplates** see page 27.

**Dimensions:** Direct voltage – central connection  
(dimensions in mm [inch])

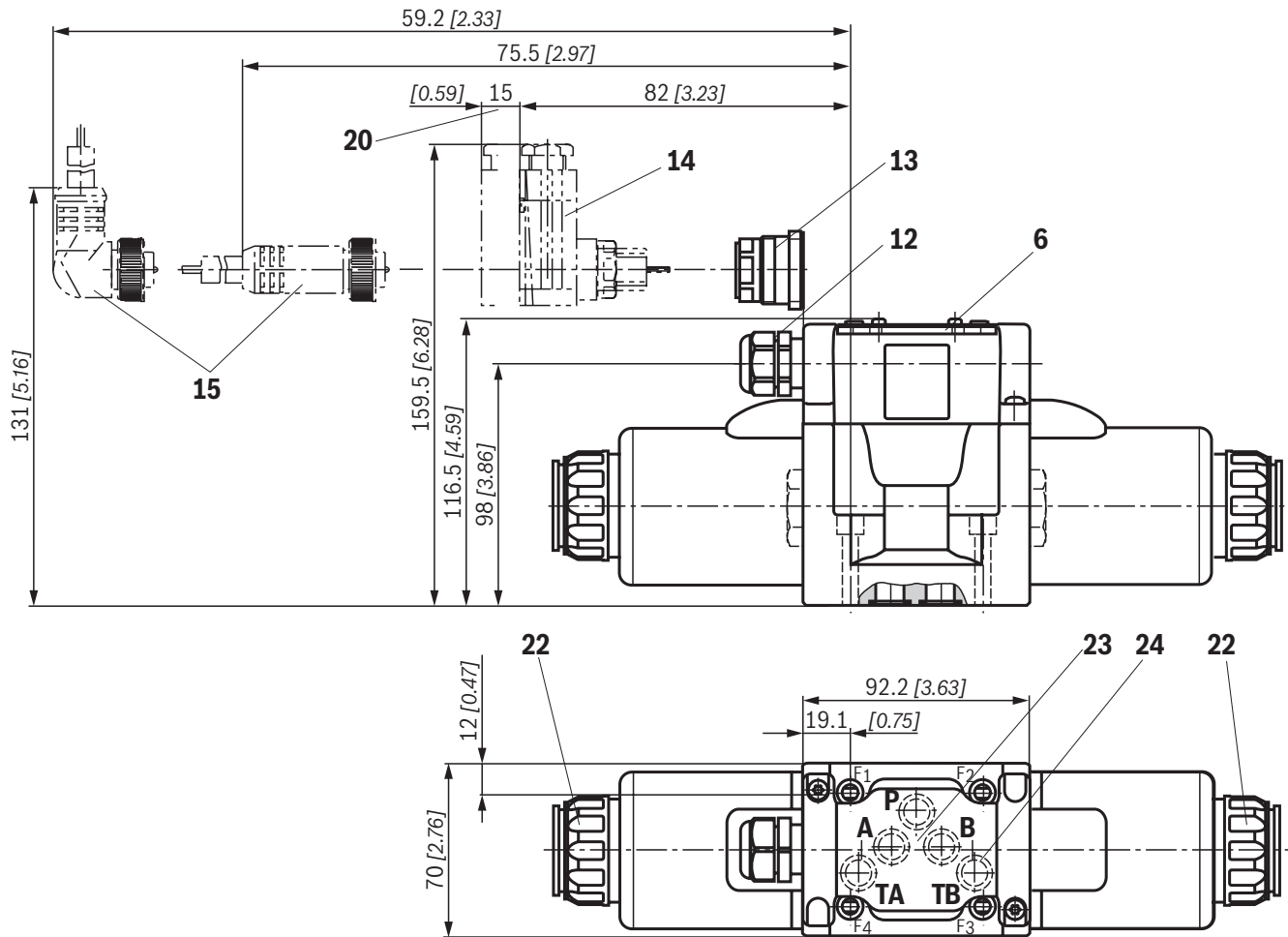

**Dimensions for manual overrides** see page 25.

**Item explanations, valve mounting screws and subplates** see page 27.

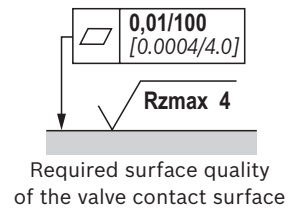

**Notice:**

The dimensions are nominal dimensions which are subject to tolerances.



**Dimensions:** Direct voltage – manual overrides  
(dimensions in mm [inch])

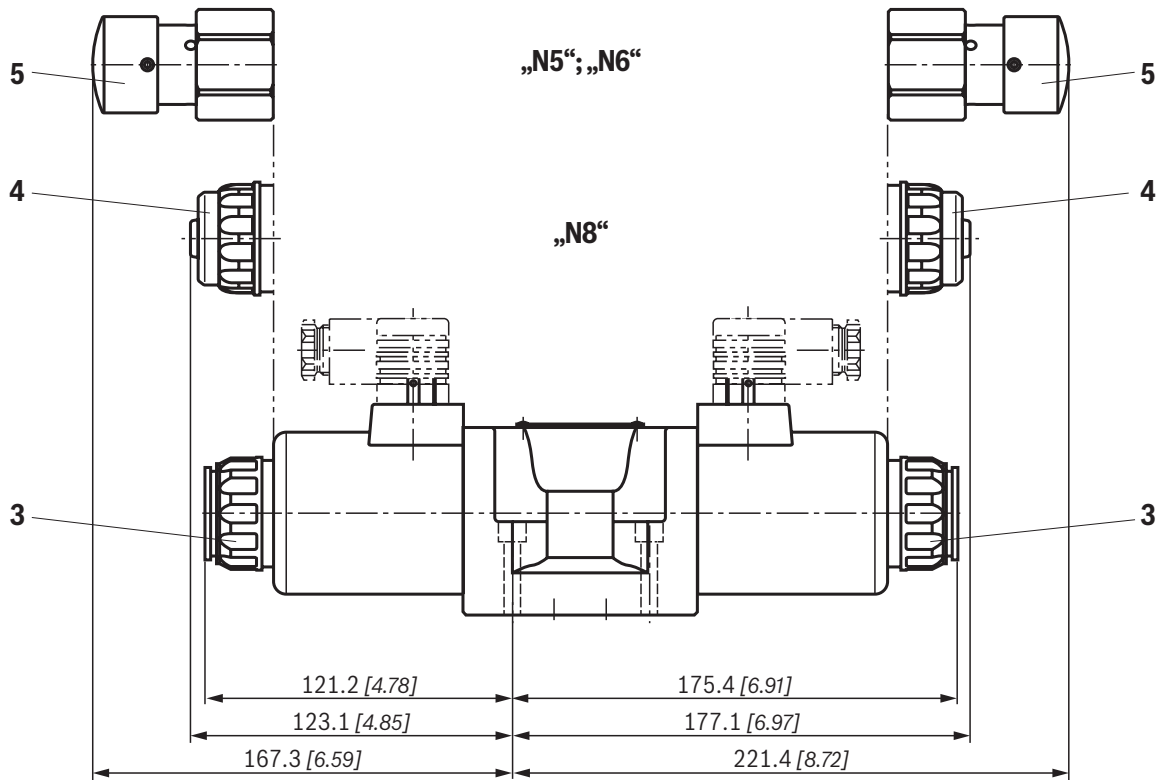

- 3 Without and with concealed manual override "N9" (standard)
- 4 With concealed manual override and protective cap "N8". (The protective cap must be removed prior to actuation.)
- 5 Lockable manual override "mushroom button" "N5" and "N6"

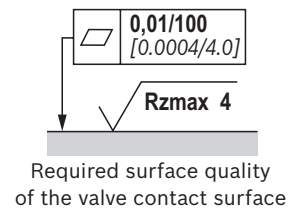

**Notice:**

The dimensions are nominal dimensions which are subject to tolerances.

**Dimensions:** Alternating voltage – individual connection  
(dimensions in mm [inch])

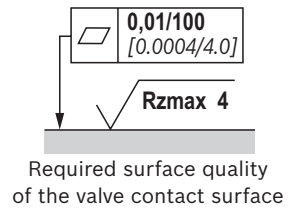
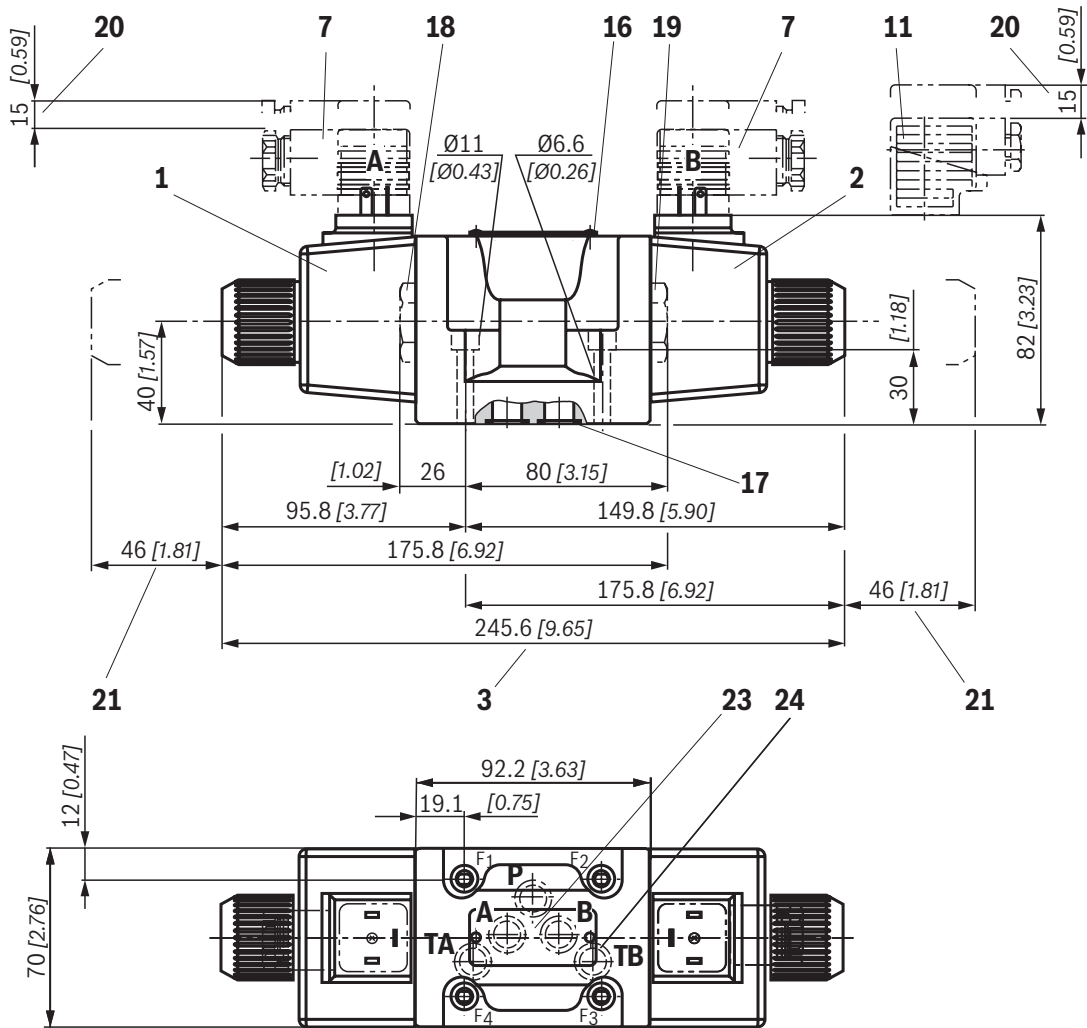

**Notice:**

- ▶ Deviating from ISO 4401, port T is called TA and port T1 is called TB in this data sheet.
- ▶ The dimensions are nominal dimensions which are subject to tolerances.

**Item explanations, valve mounting screws and subplates** see page 27.

## Dimensions

- 1 Solenoid "a"
- 2 Solenoid "b"
- 3 **Without and with concealed** manual override "N9" (standard)
- 4 With concealed manual override and protective cap "N8". (The protective cap must be removed prior to actuation.)
- 5 Lockable manual override "mushroom button" "N5" and "N6"
- 6 Cover  
**Notice:** The valve may only be operated with properly mounted cover.
- 7 Mating connector **without** circuitry for connector "K4" and "K4K" (separate order, see page 30 and data sheet 08006)
- 8 Mating connector angled with M12x1 plug-in connection and status LED for connector "K72L" (separate order, see page 30 and data sheet 08006)
- 9 Double mating connector **without/with** circuitry for connector "K4" (separate order, see page 30 and data sheet 08006)
- 10 Mating connector (AMP Junior Timer) with connector "C4Z" (separate order, see page 30 and data sheet 08006)
- 11 Mating connector **with** circuitry for connector "K4" (separate order, see page 30 and data sheet 08006)
- 12 Cable gland "DL" and "DAL"
- 13 Central plug-in connection "DK6L" and "DK25L"
- 14 Mating connectors for valves with central connection with connector "DK6L" (separate order, see page 30 and data sheet 08006)
- 15 Mini-change connector, 5-pole for connector "DK25L" (separate order, material no. **R900057631**)
- 16 Name plate
- 17 Identical seal rings for ports A, B, P, TA, TB
- 18 Plug screw for valves with one solenoid on B side
- 19 Plug screw for valves with one solenoid on A side
- 20 Space required to remove the mating connector/angled socket
- 21 Space required to remove the coil
- 22 Mounting nut, tightening torque  $M_A = 14.5 \pm 1.5 \text{ Nm}$  [10.69±1.1 ft-lbs]
- 23 Porting pattern according to ISO 4401-05-04-0-05 and NFPA T3.5.1 R2-2002 D05
- 24 Connection TB can only be used in connection with separately produced bore.

**Subplates** (separate order) with porting pattern according to ISO 4401-05-04-0-05 see data sheet 45100.

### Valve mounting screws (separate order)

| Size | Quantity | Hexagon socket head cap screws   | Material number                            |
|------|----------|--|--|
| 10   | 4        | <b>ISO 4762 - M6 x 40 - 10.9-CM-Fe-ZnNi-5-Cn-T0-H-B</b><br>Friction coefficient $\mu_{\text{total}} = 0.09 \dots 0.14$ ; tightening torque $M_A = 12.5 \text{ Nm}$ [9.2 ft-lbs] ±10%   | <b>R913051533</b>                          |
|      | or       |  |  |
|      | 4        | <b>ISO 4762 - M6 x 40 - 10.9</b><br>Friction coefficient $\mu_{\text{total}} = 0.12 \dots 0.17$ ; tightening torque $M_A = 15.5 \text{ Nm}$ [11.4 ft-lbs] ±10%   | Not included in the Rexroth delivery range |
|      | or       |  |  |
|      | 4        | <b>1/4-20 UNC x 1-1/2" ASTM-A574</b><br>Friction coefficient $\mu_{\text{total}} = 0.19 \text{ to } 0.24$ ; tightening torque $M_A = 25 \text{ Nm}$ [18.4 ft-lbs] ±15%<br>Friction coefficient $\mu_{\text{total}} = 0.12 \text{ to } 0.17$ ; tightening torque $M_A = 19 \text{ Nm}$ [14.0 ft-lbs] ±10% | <b>R978800710</b>                          |



#### Notice:

In case of different friction coefficients, the tightening torques are to be adjusted accordingly.

## Electrical connections, assignment – individual connection

### Electrical connections and coil connection combinations

| Ordering code connector   |                              | Top view | Circuit diagram | Pin                   | Connections, assignment  |
|---|------------------------------|----------|-----------------|-----------------------|--|
| Connector, 3-pole (2+PE) according to DIN EN 175301-803 (IP65)  | <b>K4, K4K</b> <sup>3)</sup> |          |                 | 1<br>2<br>⊕           | Solenoid coil, polarity-independent<br>Connection for protective grounding conductor             |
| Connector 4-pole according to IEC 60947-5-2, M12x1 with suppressor diode, only 24 V DC, integrated interference protection circuit and status LED | <b>K72L</b>                  |          |                 | 1<br>2<br>3<br>4<br>5 | Internal bridge<br>Solenoid coil GND<br>Solenoid coil 24 V DC supply voltage<br>without function |
| 2-pole connector, type AMP Junior-Timer, rotated by 90° relative to valve axis  | <b>C4Z</b>                   |          |                 | 1<br>2                | Solenoid coil, polarity-independent  |

3) Coil with potted-in connector base and sealing element to valve housing (IP65)

4) M3, tightening torque maximum  $M_{A \max} = 0.5 \text{ Nm}$  [0.37 ft-lbs]

**In the electrical connection, the protective grounding conductor (PE ⊕) is to be properly connected.**

**Notice:**

- ▶ Electric lines must be routed in a strain-relieved manner.
- ▶ Cable and line entries are only suitable for permanently installed lines.
- ▶ Connectors are to be locked during operation. The plug-in connection is not suitable to be plugged in or disconnected under load.
- ▶ Protective grounding conductor cross-section equal to or greater than the line cross-section of the voltage supply.
- ▶ The valve mounting surface must be connected to the protective grounding conductor system.

## Electrical connections, assignment – central connection

### Electrical connections and coil connection combinations

| Ordering code connector   | Top view          | Circuit diagram    | Pin                             | Connections, assignment   |
|---|-------------------|--------------------|---------------------------------|---|
| Cable gland at the cover, with indicator light (terminal area 6 ... 12 mm [0.23 ... 0.47 inch])   | <b>DL</b><br>     | Direct voltage<br> | 1+<br>2-<br>3+<br>4-            | Valve solenoid "a" 1)<br>Valve solenoid "b" 1)  |
| Cable gland at the cover, with indicator light and cable bridge at the ground connection (terminal area 6 ... 12 mm [0.23 ... 0.47 inch]) | <b>DJL</b><br>    | AC voltage<br>     | 3+<br>4-<br>⊕                   | Valve solenoid "b" 1)<br>Connection for protective grounding conductor                                |
| Without mating connector; threaded connection 1/2"-14 NPT (terminal area 6 ... 12 mm [0.23 ... 0.47 inch])                                | <b>DAL</b> 3)<br> | AC voltage<br>     | ⊕                               | Connection for protective grounding conductor   |
| Central plug-in connection at the cover, with indicator light (without mating connector) with connector according to DIN EN 175201-804    | <b>DK6L</b><br>   |                    | 1<br>2<br>3<br>4<br>5<br>6<br>⊕ | Valve solenoid "a"<br>Valve solenoid "b"<br>not used<br>Connection for protective grounding conductor |
| Mini-change connector, 5-pole according to ANSI/B93.55M-1981  | <b>DK25L</b><br>  |                    | 1<br>5<br>2<br>4<br>⊕           | Valve solenoid "b"<br>Valve solenoid "a"<br>Connection for protective grounding conductor             |

1) Core marking:

- + → red
- → blue

2) Wire bridge with version "DJL"

3) Cable gland according to conduit system with NPT thread; tightening torque  $M_A = 5 \pm 0.5$  Nm

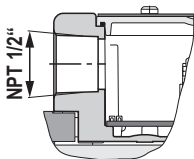

**When establishing the electrical connection, the protective grounding conductor (PE ⊕) must be connected correctly.**

See notice page <?>.

**Accessories** (separate order)**Mating connectors and cable sets**

| Item <sup>1)</sup> | Designation  | Type   | Short designation | Material number   | Data sheet |
|--------------------|--|--|-------------------|-------------------|------------|
| <b>7, 11</b>       | Mating connector, for valves with "K4" connector, 2-pole + PE, design A                      | Without circuitry, M16 x 1.5, 12 ... 240 V, "a"              | Z4                | <b>R901017010</b> | 08006      |
|                    |  | Without circuitry, M16 x 1.5, 12 ... 240 V, "b"              |                   | <b>R901017011</b> |            |
|                    |  | Without circuitry, NPT 1/2", 12 ... 240 V, "a"               | Z45               | <b>R900004823</b> |            |
|                    |  | Without circuitry, NPT 1/2", 12 ... 240 V, "b"               |                   | <b>R900011039</b> |            |
|                    |  | With indicator light, M16 x 1.5, 12 ... 240 V                | Z5L               | <b>R901017022</b> |            |
|                    |  | With indicator light, NPT 1/2", 12 ... 240 V                 | Z55L              | <b>R900057453</b> |            |
|                    |  | With rectifier, M16 x 1.5, 80 ... 240 V                      | RZ5               | <b>R901017025</b> |            |
|                    |  | With rectifier, NPT 1/2", 80 ... 240 V                       | RZ55              | <b>R900842566</b> |            |
|                    |  | With indicator light and Z-diode-suppressor, M16 x 1.5, 24 V | Z5L1              | <b>R901017026</b> |            |
|                    |  | With indicator light and rectifier, M16 x 1.5, 80 ... 240 V  | RZ5L              | <b>R901017029</b> |            |
|                    |  | With indicator light and rectifier, NPT 1/2", 80 ... 240 V   | RZ55L             | <b>R900057455</b> |            |
| <b>10</b>          | Mating connectors; for directional valves with "C4" connector (AMP Junior-Timer)             | 10 ... 32 V, 5 A   | 2P JUNIOR D2 2    | <b>R901022127</b> |            |
|                    |  | 10 ... 32 V, 5 A   | 2P D1.2 JUNIOR    | <b>R900313533</b> |            |
| <b>8</b>           | Mating connectors; for sensors and valves with "K24", "K35" and "K72" connectors, 4-pole     | M12 x 1, angled, PG 7  | 4PZ24             | <b>R900779509</b> |            |
|                    |  | M12 x 1, angled, PG 7  |                   | <b>R900082899</b> |            |
| <b>9</b>           | Cable sets; for valves with two solenoids (double mating connectors) and connector "M12 x 1" | 24 V, 4 A  | Z60               | <b>R901207825</b> |            |
|                    |  | With indicator light, 24 V, 4 A                              | Z60L              | <b>R901207824</b> |            |
|                    |  | With indicator light and Z-diode-suppressor, 24 V, 4 A       | Z60L8             | <b>R901207823</b> |            |
|                    |  | With free line end, 230 V, 4 A, 3 m                          | Z61               | <b>R901207826</b> |            |
|                    |  | With free line end, 230 V, 4 A, 5 m                          |                   | <b>R901207892</b> |            |
| <b>14</b>          | Mating connectors; for valves with central connection with "DK6L" connector                  | 250 V, 10 A, PG 11   | 7PZ6              | <b>R900002803</b> |            |

<sup>1)</sup> See dimensions page 23 ... 26.

**Energy savings and fast switching <sup>1)</sup>**

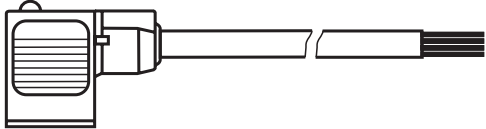
|                              |       |   |  |
|------------------------------|-------|---|--|
| Details see data sheet 30362 |       |                                   |  |
|                              |       | <b>Material number</b>  |  |
|                              |       | Type VT-SSBA1-PWM-1X/V001/5<br>as fast switching amplifier<br>(switching time reduction by approx. 50%) <sup>2)</sup> | Type VT-SSBA1-PWM-1X/V002/5<br>for energy reduction<br>(energy savings of approx. 40%) <sup>3)</sup> |
| a/b                          | black | <b>R901265633</b>   | <b>R901290194</b>  |

<sup>1)</sup> Only with symbols C, D, E, E67, J, J2 and Y; not for version "D" with reinforced compression spring

<sup>2)</sup> Only for version "G12" and "K4/K4K"

<sup>3)</sup> Only for version "G24" and "K4/K4K"

**Cartridge with PWM connector** according to data sheet 30362:

- ▶ Depending on the control spool, increasing the performance limit is possible.
- ▶ With version "G24" (energy saving), the coil temperature is reduced by  $\geq 30$  °C for 100% duty cycle.

## Project planning information

### Temperature range and maximum operating pressure in case of use at low temperatures

| Port       | Pressure  | Temperature range in °C [°F] |
|------------|---|------------------------------|
| P, A, B, T | static 100 bar [1450 psi]   | -40 ... -35 [-40 ... -31]    |
| P, A, B    | dynamic from 100 bar [1450 psi] to 350 bar [5076 psi] in linear form as a function of the temperature | -35 ... -30 [-31 ... -22]    |
| T          | dynamic from 100 bar [1450 psi] to 210 bar [3050 psi] in linear form as a function of the temperature | -35 ... -30 [-31 ... -22]    |
| P, A, B, T | Maximum operating pressure  | -30 ... +50 [-22 ... 122]    |

## Further information

- ▶ Hydraulic valves for industrial applications Data sheet 07600-B
- ▶ Subplates Data sheet 45100
- ▶ Hydraulic fluids on mineral oil basis Data sheet 90220
- ▶ Environmentally compatible hydraulic fluids Data sheet 90221
- ▶ Flame-resistant, water-free hydraulic fluids Data sheet 90222
- ▶ Flame-resistant hydraulic fluids - containing water (HF AE, HF AS, HF B, HF C) Data sheet 90223
- ▶ Connector switching amplifier type VT-SSBA1 Data sheet 30362
- ▶ Directional spool and seat valves with electrical actuation and M12x1 plug-in connection Data sheet 08010
- ▶ Reliability characteristics according to EN ISO 13849 Data sheet 08012
- ▶ CE declaration of conformity according to Low-Voltage Directive 2014/35/EU upon request
- ▶ Selection of filters [www.boschrexroth.com/filter](http://www.boschrexroth.com/filter)
- ▶ Information on available spare parts [www.boschrexroth.com/spc](http://www.boschrexroth.com/spc)

## Notes

Bosch Rexroth AG  
Industrial Hydraulics  
Zum Eisengießer 1  
97816 Lohr am Main, Germany  
Phone +49 (0) 93 52/40 30 20  
my.support@boschrexroth.de  
www.boschrexroth.de

© All rights reserved to Bosch Rexroth AG, also regarding any disposal, exploitation, reproduction, editing, distribution, as well as in the event of applications for industrial property rights.  
The data specified above only serve to describe the product. No statements concerning a certain condition or suitability for a certain application can be derived from our information. The information given does not release the user from the obligation of own judgment and verification.  
It must be remembered that our products are subject to a natural process of wear and aging.