

Directional spool valves, direct operated,
with manual actuation

Type WMM ...XC

RE 22280-XC
Edition: 2016-04
Replaces: 07.09

- ▶ Size 6
- ▶ Component series 5X
- ▶ Maximum operating pressure 315 bar
- ▶ Maximum flow 60 l/min

**ATEX units**
For potentially explosive areas**Information on the explosion protection:**

- ▶ Area of application in accordance with the Explosion Protection Directive 2014/34/EU: **IM2, II2G, II2D, II3G, II3D**
- ▶ Type of ignition protection of the valve: c (EN 13463-5)

Features

- ▶ 4/3-, 4/2- or 3/2-way version
- ▶ For intended use in potentially explosive atmosphere
- ▶ Porting pattern according to ISO 4401-03-02-0-05 (with or without locating hole)
- ▶ Type of actuation:
 - Hand lever

Contents

Features	1
Ordering code	2
Symbols	3
Types of actuation	4
Function, section	5
Technical data	6, 7
Actuating force/torque	7
Characteristic curves	7
Performance limits	8
Dimensions	9
Further information	10

Ordering code

01	02	03	04	05	06	07	08	09	10
	WMM	6		5X	/	XC			

01	3 main ports	3
	4 main ports	4

Type of actuation

02	Hand lever	WMM
03	Size 6	6
04	Symbols e.g. C, E, EA, EB, etc.; possible version see page 3 and 4	
05	Component series 50 ... 59 (50 ... 59: unchanged installation and connection dimensions)	5X

Spool return

06	With spring return	no code
	Without spring return with detent	F

Explosion protection

07	"Non-electrical devices"	XC
	For details, see information on the explosion protection page 7	
08	Without throttle insert	no code
	Throttle Ø 0.8 mm	B08 ¹⁾
	Throttle Ø 1.0 mm	B10 ¹⁾
	Throttle Ø 1.2 mm	B12 ¹⁾

Seal material

09	NBR seals	no code
	FKM seals	V
	Observe compatibility of seals with hydraulic fluid used. (Other seals upon request)	
10	Without locating hole	no code
	With locating hole	/60 ²⁾
	With locating hole and locking pin ISO 8752-3x8-St	/62

¹⁾ Use if flow > performance limit of the valve, effective in channel P.

²⁾ Grooved pin ISO 8741-3x8-St-A2C, material no. **R900005076** (separate order).

Symbols

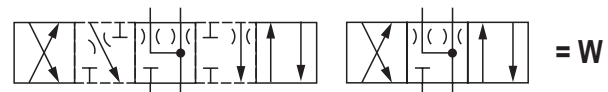
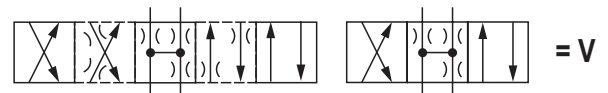
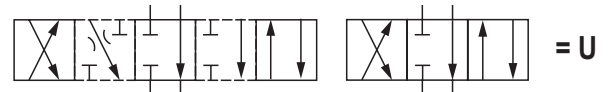
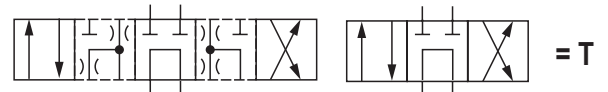
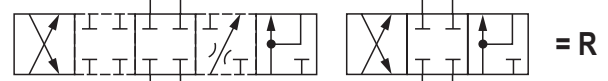
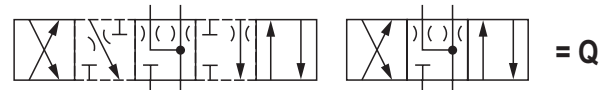
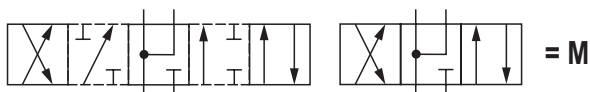
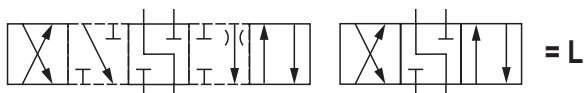
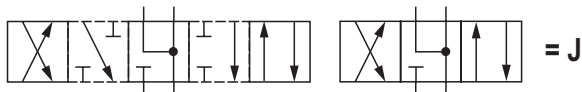
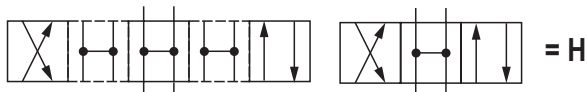
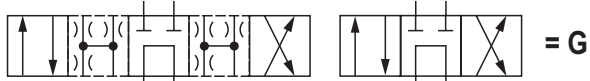
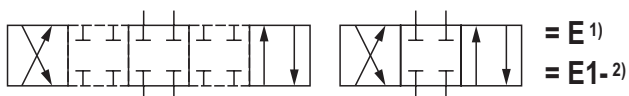
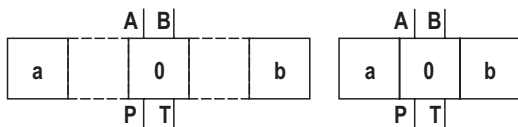
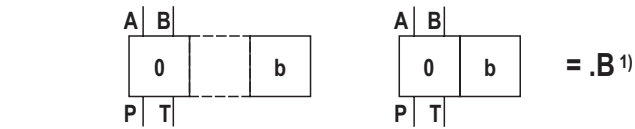
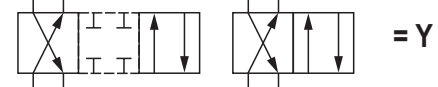
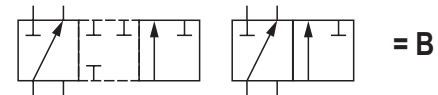
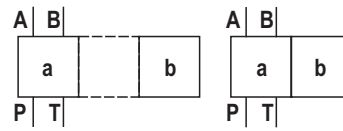
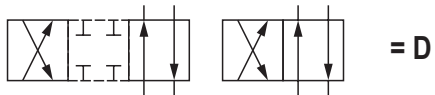
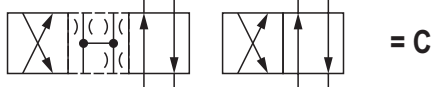
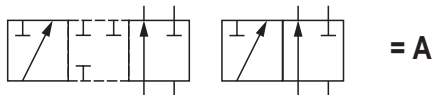
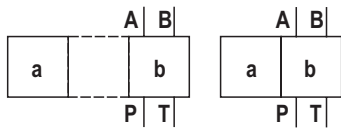

1) **Example:**

Symbol E with spool position "a" → ordering code ..EA..

Symbol E with spool position "a" → ordering code ..EB..

2) **Symbol E1:** P → A/B pre-opening

Caution in conjunction with differential cylinders due to pressure intensification!

Notices:

Representation according to DIN ISO 1219-1.

Hydraulic interim positions are shown by dashes.

Types of actuation

Symbol	Ordering code		Type of actuation Hand lever "WMM"
	Actuating side	Detent	
A, C, D		../F..	
B, Y			
		../F..	
E1-, E, F, G, H, J, L M, P, Q, R, T, U, V, W	"a" 1) = .A	../F..	
	"b" 1) = .B	../F..	
		../F..	

1) See symbols on page 3

Function, section

Type WMM 6...XC valves are manually actuated directional spool valves. They control start, stop and direction of flow. The directional valves basically consist of housing (1), one type of actuation (2) (hand lever), control spool (3), and one or two return springs (4).

In the de-energized condition, the control spool (3) is held in the central or initial position by the return springs (4). The control spool (3) is moved to the desired spool position by means of the type of actuation.

Detent

Directional valves with hand lever are optionally available as 2 or 3 position valves with detent. If types of actuation with detent are used, each spool position can be locked, depending on the valve type.

Throttle insert

The use of a throttle insert is required when due to prevailing operating conditions, flows can occur during the switching processes, which exceed the performance limit of the valve.

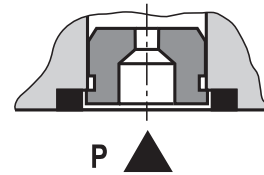

Type .WMM 6 .5X/.XCB...

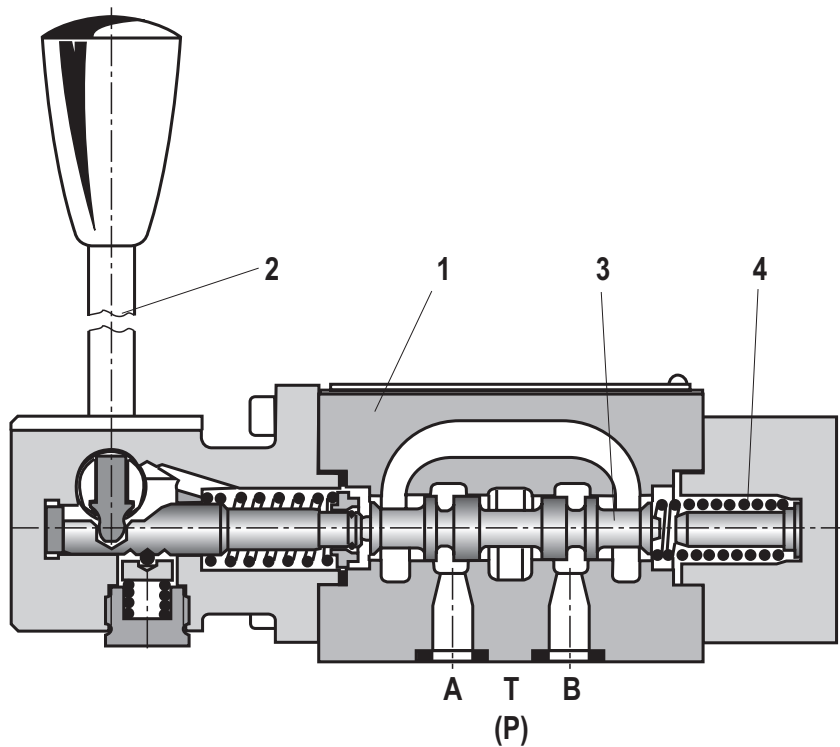

Type .WMM 6 .5X/FXC...

Technical data

(For application outside these parameters, please consult us!)

general		
Weight	kg	Approx. 1.4
Installation position		Any
Ambient temperature range	°C	-30 ... +80 (NBR seals) -20 ... +80 (FKM seals)
Storage temperature range	°C	+5 ... +40
Maximum storage time	Years	1
Surface protection		Galvanized

hydraulic				
Maximum operating pressure	- Ports A, B, P	bar	315	With symbols A or B, port T must be used as leakage oil connection if the operating pressure exceeds the admissible tank pressure. 2 bar minimum preload pressure required.
	- Port T		100	
Maximum flow		l/min	60	
Flow cross-section (spool position 0)	- Symbol Q	mm ²	Approx. 6 % of nominal cross-section	
	- Symbol W	mm ²	Approx. 3 % of nominal cross-section	
Hydraulic fluid			See table below	
Hydraulic fluid temperature range		°C	-30 ... +80 (NBR seals) -20 ... +80 (FKM seals)	
Viscosity range		mm ² /s	2.8 ... 500	
Maximum admissible degree of contamination of the hydraulic fluid Cleanliness class according to ISO 4406 (c)			Class 20/18/15 ¹⁾	
Maximum surface temperature		°C	See information on the explosion protection, page 7	

Hydraulic fluid	Classification	Suitable sealing materials	Standards	Data sheet
Mineral oils	HL, HLP, HLPD, HVLP, HVLPD	NBR, FKM	DIN 51524	90220
Bio-degradable	▶ Insoluble in water	HETG	ISO 15380	90221
		HEES		
	▶ Soluble in water	HEPG	ISO 15380	
Flame-resistant	▶ Water-free	HFDU, HFDR	ISO 12922	90222
	▶ Containing water	HFC (Fuchs Hydrotherm 46M, Petrofer Ultra Safe 620)	ISO 12922	90223

**Important information on hydraulic fluids:**

- ▶ For further information and data on the use of other hydraulic fluids, please refer to the data sheets above or contact us!
- ▶ There may be limitations regarding the technical valve data (temperature, pressure range, life cycle, maintenance intervals, etc.)!
- ▶ The ignition temperature of the hydraulic fluid used must be 50 K higher than the maximum solenoid surface temperature.

▶ Flame-resistant – containing water:

- Maximum pressure differential per control edge 50 bar
- Pressure pre-loading at the tank port > 20 % of the pressure differential, otherwise increased cavitation
- Life cycle as compared to operation with mineral oil HL, HLP 50 ... 100 %

¹⁾ The cleanliness classes specified for the components must be adhered to in hydraulic systems. Effective filtration prevents faults and at the same time increases the life cycle of the components.

For the selection of the filters, see www.boschrexroth.com/filter.

Technical data

(For applications outside these parameters, please consult us!)

Information on the explosion protection	
Area of application according to directive 2014/34/EU	IM2, II2G, II2D, II3G, II3D
Type of protection valve	c (EN 13463-5)
Maximum surface temperature ^{2); 3)}	°C 100
Temperature class ³⁾	T4
Ambient temperature range	°C -20 ... +80

²⁾ Surface temperature > 50 °C, provide contact protection.

³⁾ The specified values refer to the maximum hydraulic fluid and ambient temperature. Due to a maximum pressure drop across the valve, the surface temperature exceeds the hydraulic fluid temperature by 20 K, i. e. using the valve in temperature class T6 is possible if the hydraulic fluid temperature and the ambient temperature do not exceed 60 °C (also refer to the table on page 6).

Actuating force/torque

Maximum actuating torque	Ncm	-
Actuating force	▶ Without tank pressure, with/ without detent	N 20
	▶ At a tank pressure of 100 bar	N 30

Characteristic curves

(measured with HLP46, $\vartheta_{oil} = 40 \pm 5 \text{ } ^\circ\text{C}$)

Δp - q_v characteristic curves

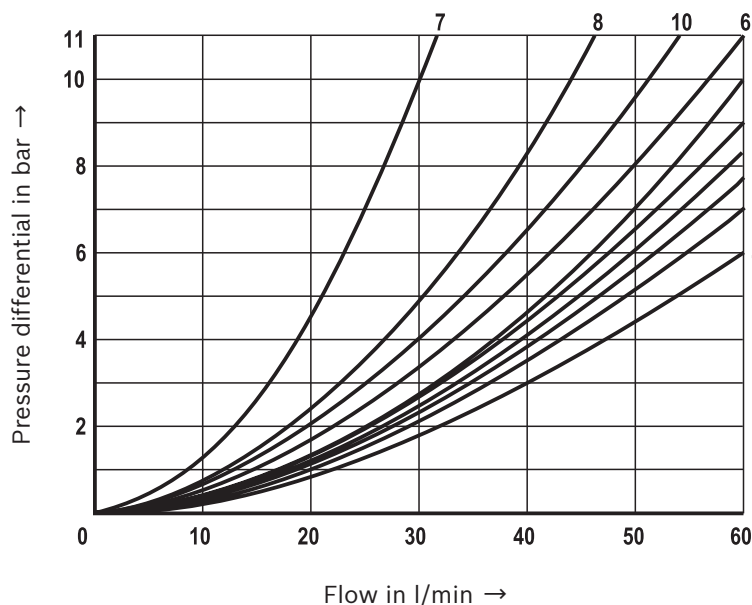

7 Symbol "R" in spool position "b" (A → B)

8 Symbols "G" and "T" in central position (P → T)

Symbol	Direction of flow			
	P-A	P-B	A-T	B-T
A	3	3	-	-
B	3	3	-	-
C	1	1	3	1
D	5	5	3	3
E	3	3	1	1
F	1	3	1	1
G	6	6	9	9
H	2	4	2	2
J	1	1	2	1
L	3	3	4	9
M	2	4	3	3
P	3	1	1	1
Q	1	1	2	1
R	5	5	4	-
T	10	10	9	9
U	3	3	9	4
V	1	2	1	1
W	1	1	2	2
Y	5	5	3	3

Performance limits

(measured with HLP46, $\vartheta_{oil} = 40 \pm 5 \text{ }^\circ\text{C}$)

Notice:

The specified switching power limits are valid for operation with two directions of flow (e. g. from P to A and simultaneous return flow from B to T).

Due to the flow forces acting within the valves, the admissible switching power limit may be considerably lower with only one direction of flow (e.g. from P to A while port B is blocked)!
In such cases, please consult us!

Version "WMM" - spring return

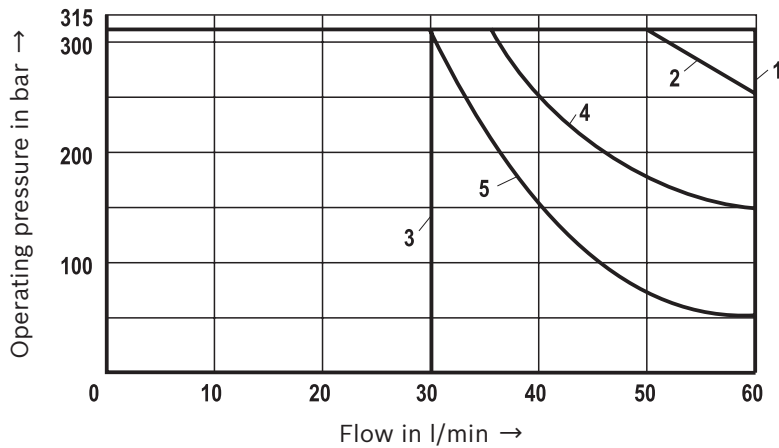

Characteristic curve	Symbol
1	E, E1-, M, J, L, Q, U, W, C, D, Y, G, H, R
2	A, B
3	V
4	F, P
5	T

Version "WMM" - with detent

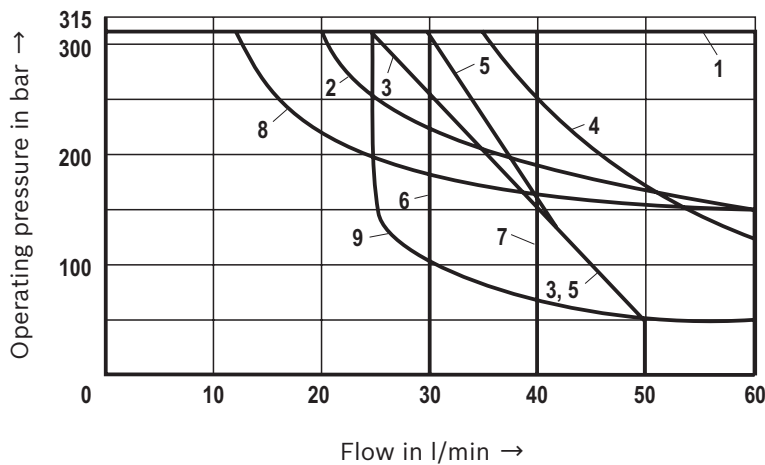

Characteristic curve	Symbol
1	E1-, M, H, C, D, Y
2	E, J, Q, L, U, W
3	A, B
4	G, T
5	F
6	V
7	P
8	R
9	T

Dimensions
(dimensions in mm)

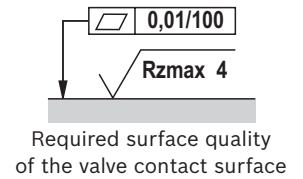
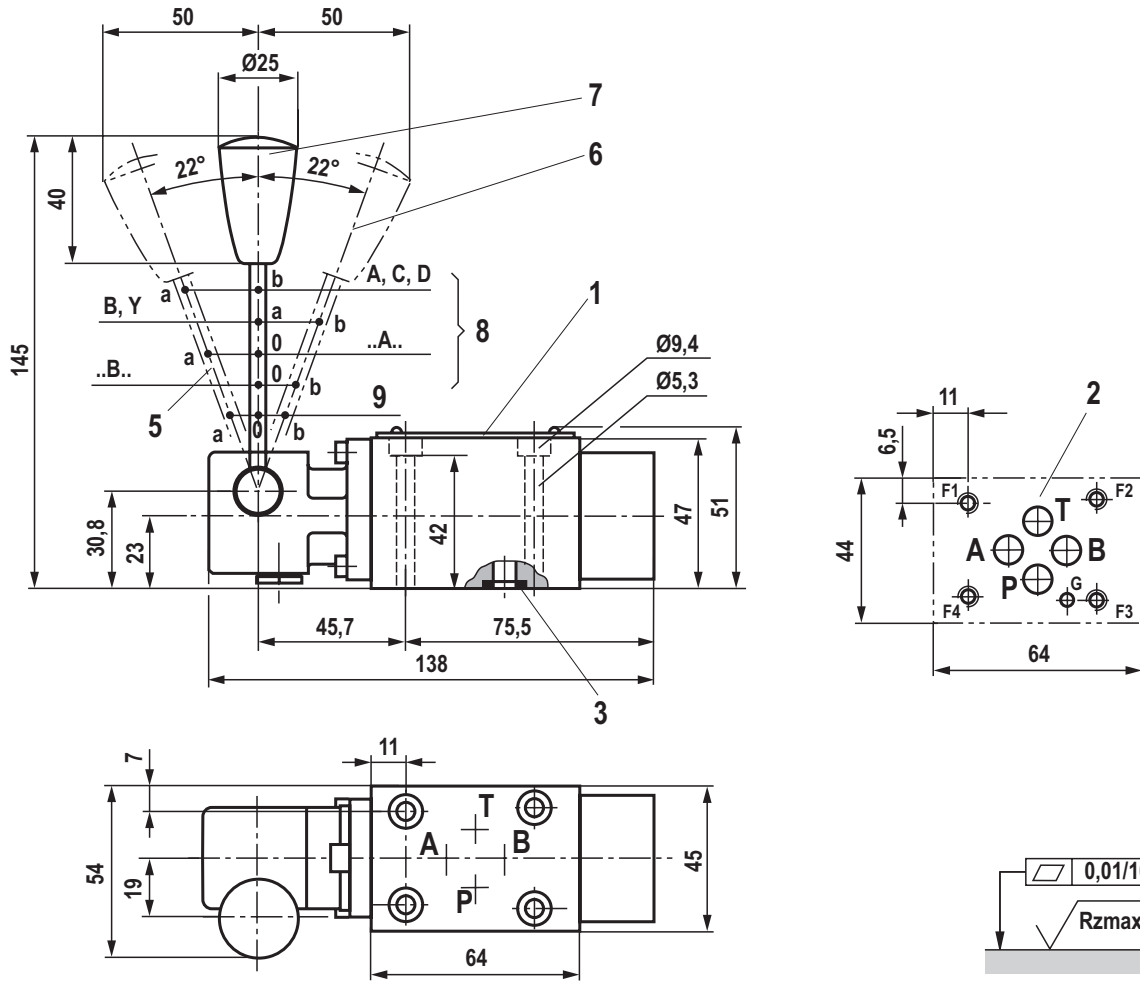

- 1 Name plate
- 2 Porting pattern according to ISO 4401-03-02-0-05 (without or with locating hole for locking pin ISO 8752-3x8-St, material no. **R900005694**, separate order)
- 3 Identical seal rings for ports A, B, P and T
- 5 Spool position "a"
- 6 Spool position "b"
- 7 Spool position "0", "a" and "b" (a and b for valves with 2 spool positions)
- 8 Valve with 2 spool positions
- 9 Valve with 3 spool positions

Valve mounting screws (separate order)

For reasons of stability, exclusively use the following valve mounting screws:

4 hexagon socket head cap screws

ISO 4762 - M5 x 50 - 10.9-f1Zn-240h-L

(friction coefficient $\mu_{total} = 0.09 \dots 0.14$);
material no. **R913000064**

Subplates (separate order) with porting pattern according to ISO 4401-03-02-0-05, see data sheet 45100.

Notice:

Subplates are no components in the sense of directive 2014/34/EU and can be used after the manufacturer of the overall system has conducted an assessment of the risk of ignition. The "G...J3" versions are free from aluminum and/or magnesium and galvanized.

Further information

- ▶ Subplates
- ▶ Hydraulic fluids on mineral oil basis
- ▶ Environmentally compatible hydraulic fluids
- ▶ Flame-resistant, water-free hydraulic fluids
- ▶ Flame-resistant hydraulic fluids - containing water (HFAE, HFAS, HFB, HFC)
- ▶ Directional spool valves, direct operated, with manual actuation
- ▶ Selection of filters
- ▶ Information on available spare parts

Data sheet 45100

Data sheet 90220

Data sheet 90221

Data sheet 90222

Data sheet 90223

Operating instructions 22280-XC-B

www.boschrexroth.com/filter

www.boschrexroth.com/spc

Bosch Rexroth AG
Hydraulics
Zum Eisengießer 1
97816 Lohr am Main, Germany
Phone +49 (0) 93 52/ 18-0
documentation@boschrexroth.de
www.boschrexroth.de

© This document, as well as the data, specifications and other information set forth in it, are the exclusive property of Bosch Rexroth AG. It may not be reproduced or given to third parties without its consent.
The data specified above only serve to describe the product. No statements concerning a certain condition or suitability for a certain application can be derived from our information. The information given does not release the user from the obligation of own judgment and verification. It must be remembered that our products are subject to a natural process of wear and aging.

Notes

Bosch Rexroth AG
Hydraulics
Zum Eisengießer 1
97816 Lohr am Main, Germany
Phone +49 (0) 93 52/18-0
documentation@boschrexroth.de
www.boschrexroth.de

© This document, as well as the data, specifications and other information set forth in it, are the exclusive property of Bosch Rexroth AG. It may not be reproduced or given to third parties without its consent.
The data specified above only serve to describe the product. No statements concerning a certain condition or suitability for a certain application can be derived from our information. The information given does not release the user from the obligation of own judgment and verification. It must be remembered that our products are subject to a natural process of wear and aging.

Notes

Bosch Rexroth AG
Hydraulics
Zum Eisengießer 1
97816 Lohr am Main, Germany
Phone +49 (0) 93 52/18-0
documentation@boschrexroth.de
www.boschrexroth.de

© This document, as well as the data, specifications and other information set forth in it, are the exclusive property of Bosch Rexroth AG. It may not be reproduced or given to third parties without its consent.
The data specified above only serve to describe the product. No statements concerning a certain condition or suitability for a certain application can be derived from our information. The information given does not release the user from the obligation of own judgment and verification. It must be remembered that our products are subject to a natural process of wear and aging.